

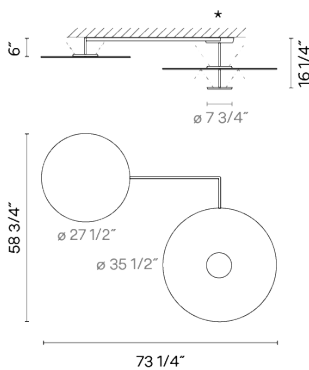



5924

Design By Ichiro Iwasaki

Flat lamps are a creation from the designer Ichiro Iwasaki. The discs of light descend from the ceiling to form a pendant, where the planes of reflected light blend in with the architecture. All the models in the Flat collection incorporate LED lighting and are available in a range of neutral color tones.

Spec sheet



Finish	 72 White, Green L1 NCS S 0300-N, NCS S 4005-G80Y
	 10 White NCS S 0300-N
	 73 White, Off-White NCS S 0300-N, NCS S 1000-N

LED color temperature 2700 K

Dimming 0-10V
Optional DALI or TRIAC
Min. Quantity, upcharge and extra lead time apply

Installation type Surface mounted



Materials
Canopy: Steel
Reflector: Aluminum
Body: Steel

Light source 3 x LED PLATE 20W 700mA

LED CRI>90 8700 lm 145
2700 K

Driver CC - Constant Current 700
120-277 V 50/60 HZ

Dimmable **LED** **IP20** **Multi-volt**

 **50-60Hz** 

Lighting effect

General Lighting

Lamp that emits an upward or backward beam that is reflected by the ceiling or wall.

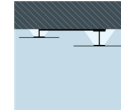

Photometric Data

Application Ceiling Fixtures

Packaging
1 Box
50.2 m x 41.73 m x 18.11 m
Gross weight 58.59
Net weight 44.01
Vol. 21.9518