

MILLER TABLE

DESIGN SPECIFICATIONS







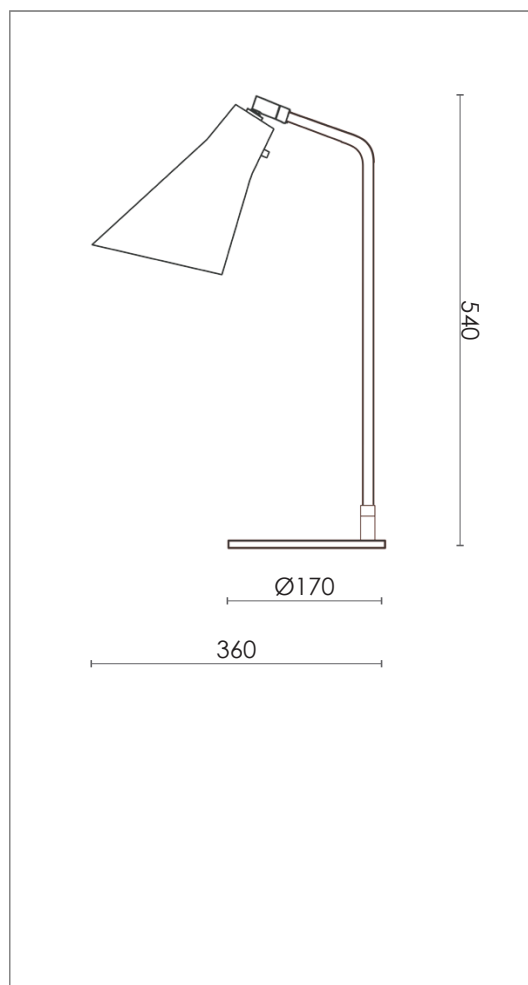

DIMENSIONS (mm)	H 540 x D 360 - BASE Ø 170
WEIGHT (kg)	2,3
MATERIALS	THE LAMP IS MADE FROM CLEAR LACQURED BRASS OR POWDER COATED STEEL
CORD (mm)	BLACK TEXTILE - L 2300
ENVIRONMENT	INDOOR
DESIGN BY	NICLAS HOFLIN
DESIGN YEAR	2014

ELECTRICAL SPECIFICATIONS

SWITCH	ON / OFF
BULB HOLDER	GU10
LIGHT SOURCE	INCLUDED DIMMABLE 4 W LED - 2700 K
DIMMABLE	YES
MAX (W)	6 W LED
VOLTAGE	230 / 240
CLASS	2
IP	20



COLOURS

 BLACK	ART.NO. 850174005	 UMBRA GREY / BRASS	ART.NO. 850171126
 BLACK / BRASS	ART.NO. 850171005	 LIGHT SAND / BRASS	ART.NO. 850171127
 SILK GREY / BRASS	ART.NO. 850171110	 SLATE GREY / STEEL	ART.NO. 850173025
 SLATE GREY / BRASS	ART.NO. 850171125	 UMBRA GREY / STEEL	ART.NO. 850173026