

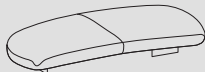







Papilo plain - Papilo curvy

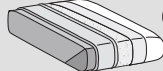

	 Seduta - Seat	 Schienali - Backrests	 Fantasmino - Low-cut	
Rivestimento Upholstering (13)	Sfoderabile Removable 	Sfoderabile Removable 	Sfoderabile Removable 	
	Non sfoderabile Not removable —	Non sfoderabile Not removable —	Non sfoderabile Not removable —	
Imbottiture Padding (2-4-5-6-7-8-9-10-11-12)	 D.35/40kg/m³	 D.40/21kg/m³ + zavorra		 Optional

INFORMAZIONI TECNICHE

Struttura: 1-4

Masselli portanti in legno di abete. Elementi strutturali in pannelli di legno multistrati in classe E1, tamponamenti in faesite.

Molleggio: 3

Seduta in nastri elastici di fibra propilenica e lattice incrociati e meccanicamente pretensionati.

Note:

Cuscini schienale fantasmino in chips di polistirene misto a fibra di poliestere in fiocco con leggera zavorra in metallo.

TECHNICAL INFORMATION

Structure: 1-4

Solid fir wood. Structural elements in multilayer wood panels in class E1, infills in faesite.

Springing: 3

Seat with pre-tensioned crossed propylene fibre and latex elastic webbing.

Note:

Low-cut back cushions in polystyrene chips mixed with polyester fibre batting and light metal weight

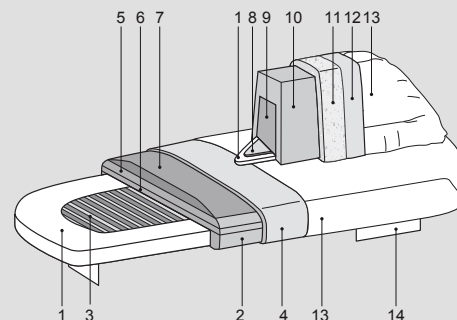
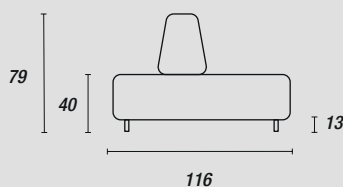

Piedini - Feet:

di serie

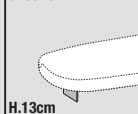

H.13cm
Eucalipto (LE05)
Grey wood (LE12)

optional Metacrilato

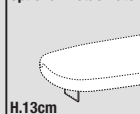

H.13cm
con maggiorazione
Metacrilato trasparente