

# Krisby



	Seduta - Seat	Schienali - Backrests	Struttura - Structure	
<b>Rivestimento Upholstering (9)</b>	Sfoderabile / Removable 	Sfoderabile / Removable 	Sfoderabile / Removable 	
	Non sfoderabile / Not removable -	Non sfoderabile / Not removable -	Non sfoderabile / Not removable 	
<b>Imbottiture Padding (4-5-6-7-8)</b>				 Optional

## INFORMAZIONI TECNICHE

### Struttura: 1

Struttura base in pannelli di legno multistrati in classe E1, Elementi strutturali in pannelli di particelle di legno in classe E1 e tamponamenti in faesite.

### Molleggio: 1-2

Schienale in pannello di particelle di legno.  
 Seduta in nastri elastici di fibra propilenica e lattice incrociati e meccanicamente pretensionati.

## TECHNICAL INFORMATION

### Structure: 1

Frame structure in plywood panels in class E1, Structural elements in wood particle panels in class E1 and infill in faesite.

### Springing: 1-2

Back panel made of wood particles.  
 Seat with pre-tensioned crossed propylene fibre and latex elastic webbing.

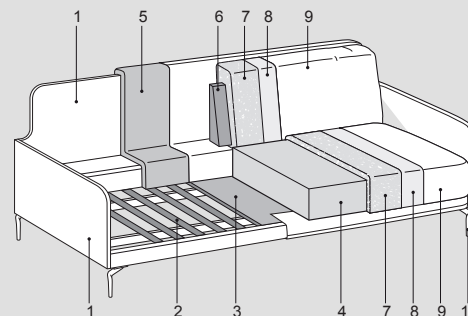
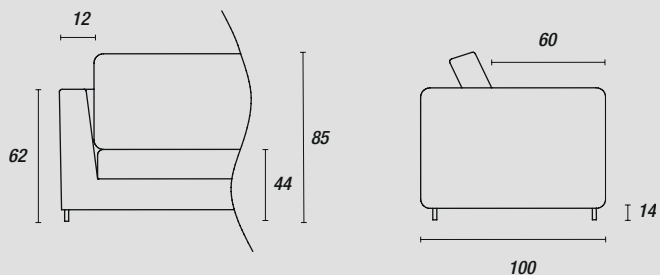

### Piedini - Feet:

#### di serie Tag



Nero (ME09)  
 Light brown (ME11)

#### optional Tag



con maggiorazione  
 Peltro (ME13)

#### optional Up



con maggiorazione  
 Nero (ME09)  
 Light brown (ME11)

#### optional Bjorg



Nero (ME09)  
 Light brown (ME11)  
 Antracite (ME01)  
 Testa di moro (ME03)

#### optional Bjorg



con maggiorazione  
 Cromo nero (ME05)  
 Peltro (ME13)





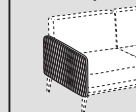



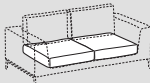
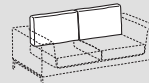
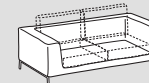

### Accessori - Accessories:

#### Bracciolo trapuntato

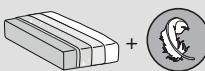

# Krisby mix



	 Seduta - Seat	 Schienali - Backrests	 Struttura - Structure	
<b>Rivestimento Upholstering (9)</b>	Sfoderabile Removable  	Sfoderabile Removable  	-	
	Non sfoderabile Not removable -	Non sfoderabile Not removable -		
<b>Imbottiture Padding (4-5-6-7-8)</b>	 D.35kg/m³	 D.21kg/m³	 Pol.espanso	 Optional

## INFORMAZIONI TECNICHE

### Struttura: 1

Struttura base in pannelli di legno multistrati in classe E1, Elementi strutturali in pannelli di particelle di legno in classe E1 e tamponamenti in faesite.

### Molleggio: 1-2

Schienale in pannello di particelle di legno.  
Seduta in nastri elastici di fibra propilenica e lattice incrociati e meccanicamente pretensionati.

### Note:

Scocca rivestita in pelle Cat. Soft; per articolo imbottito con parti in pelle di altre categorie, aggiungere la maggiorazione indicata. Bordo di serie tono su tono, se in contrasto specificare il colore.

## TECHNICAL INFORMATION

### Structure: 1

Frame structure in plywood panels in class E1, Structural elements in wood particle panels in class E1 and infill in faesite.

### Springing: 1-2

Back panel made of wood particles.  
Seat with pre-tensioned crossed propylene fibre and latex elastic webbing.

### Note:

Base covered with Soft leather; for articles upholstered with leather parts from other categories, consider the indicated surcharge. Tone on tone edge as a standard, if contrasting, specify the color.

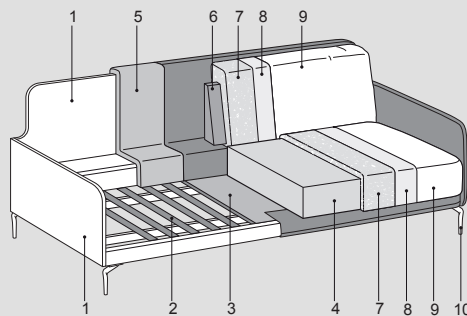
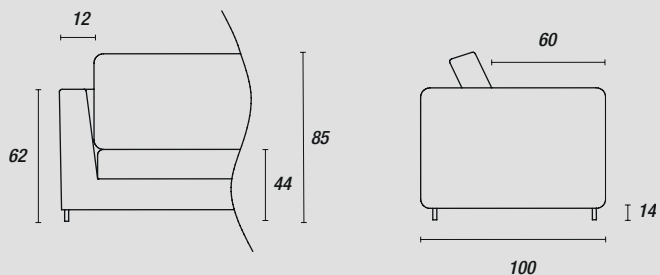

### Piedini - Feet:

#### di serie Tag



Nero (ME09)  
Light brown (ME11)

#### optional Tag



con maggiorazione  
Peltro (ME13)

#### optional Up

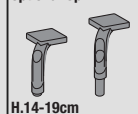

con maggiorazione  
Nero (ME09)  
Light brown (ME11)  
Light brown (ME11)

#### optional Bjorg



Nero (ME09)  
Light brown (ME11)  
Antracite (ME01)  
Testa di moro (ME03)

#### optional Bjorg



con maggiorazione  
Cromo nero (ME05)  
Peltro (ME13)

### Accessori - Accessories:

#### Bracciolo trapuntato

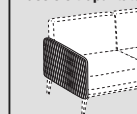

# Krisby low



	Seduta - Seat	Schienali - Backrests	Struttura - Structure	
<b>Rivestimento Upholstering (9)</b>	Sfoderabile / Removable Non sfoderabile / Not removable	Sfoderabile / Removable Non sfoderabile / Not removable	Sfoderabile / Removable Non sfoderabile / Not removable	
<b>Imbottiture Padding (4-5-6-7-8)</b>	 D.35kg/m³	 D.21kg/m³	 Pol.espanso	 Optional

## INFORMAZIONI TECNICHE

### Struttura: 1

Struttura base in pannelli di legno multistrati in classe E1, Elementi strutturali in pannelli di particelle di legno in classe E1 e tamponamenti in faesite.

### Molleggio: 1-2

Schienale in pannello di particelle di legno.  
Seduta in nastri elastici di fibra propilenica e lattice incrociati e meccanicamente pretensionati.

## TECHNICAL INFORMATION

### Structure: 1

Frame structure in plywood panels in class E1, Structural elements in wood particle panels in class E1 and infill in faesite.

### Springing: 1-2

Back panel made of wood particles.  
Seat with pre-tensioned crossed propylene fibre and latex elastic webbing.

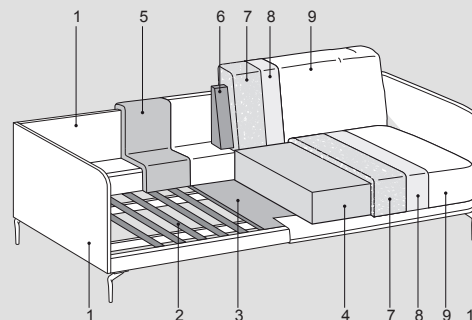
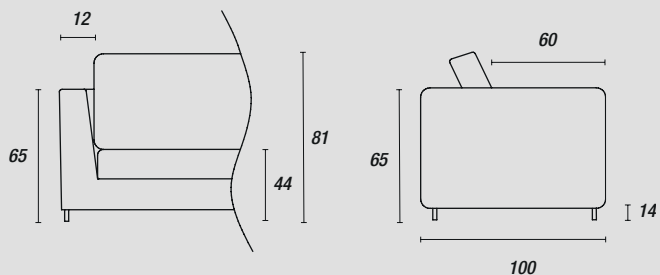

### Piedini - Feet:

#### di serie Tag



Nero (ME09)  
Light brown (ME11)

#### optional Tag



con maggiorazione  
Peltro (ME13)

#### optional Up



con maggiorazione  
Nero (ME09)  
Light brown (ME11)

#### optional Bjorg



Nero (ME09)  
Light brown (ME11)  
Antracite (ME01)  
Testa di moro (ME03)

#### optional Bjorg



con maggiorazione  
Cromo nero (ME05)  
Peltro (ME13)





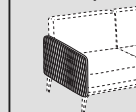



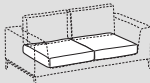
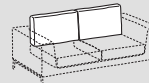
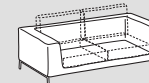

### Accessori - Accessories:

#### Bracciolo trapuntato

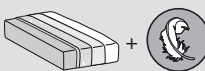

# Krisby mix low



	 Seduta - Seat	 Schienali - Backrests	 Struttura - Structure	
<b>Rivestimento Upholstering (9)</b>	Sfoderabile Removable  	Sfoderabile Removable  	-	
	Non sfoderabile Not removable -	-		
<b>Imbottiture Padding (4-5-6-7-8)</b>	 D.35kg/m³	 D.21kg/m³	 Pol.espanso	 Optional

## INFORMAZIONI TECNICHE

### Struttura: 1

Struttura base in pannelli di legno multistrati in classe E1, Elementi strutturali in pannelli di particelle di legno in classe E1 e tamponamenti in faesite.

### Molleggio: 1-2

Schienale in pannello di particelle di legno.  
Seduta in nastri elastici di fibra propilenica e lattice incrociati e meccanicamente pretensionati.

### Note:

Scocca rivestita in pelle Cat. Soft; per articolo imbottito con parti in pelle di altre categorie, aggiungere la maggiorazione indicata. Bordo di serie tono su tono, se in contrasto specificare il colore.

## TECHNICAL INFORMATION

### Structure: 1

Frame structure in plywood panels in class E1, Structural elements in wood particle panels in class E1 and infill in faesite.

### Springing: 1-2

Back panel made of wood particles.  
Seat with pre-tensioned crossed propylene fibre and latex elastic webbing.

### Note:

Base covered with Soft leather; for articles upholstered with leather parts from other categories, consider the indicated surcharge. Tone on tone edge as a standard, if contrasting, specify the color.

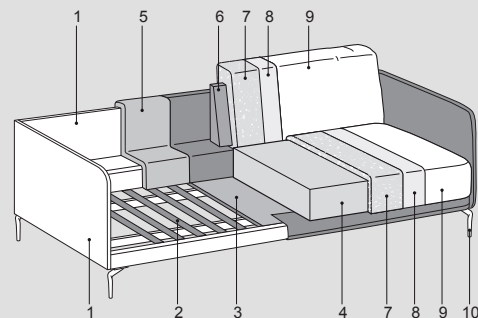
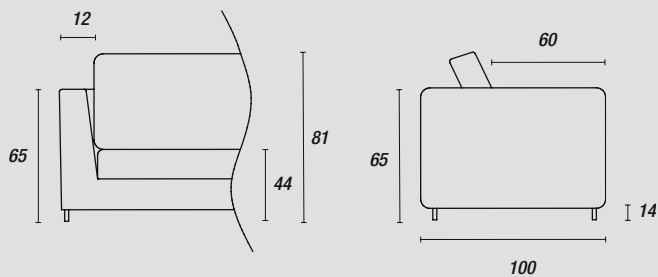

### Piedini - Feet:

#### di serie Tag



H.14cm  
Nero (ME09)  
Light brown (ME11)

#### optional Tag



H.14cm  
con maggiorazione  
Peltro (ME13)

#### optional Up

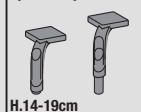

H.14-19cm  
con maggiorazione  
Nero (ME09)  
Light brown (ME11)

#### optional Bjorg



H.13cm  
Nero (ME09)  
Light brown (ME11)  
Antracite (ME01)  
Testa di moro (ME03)

#### optional Bjorg



H.13cm  
con maggiorazione  
Cromo nero (ME05)  
Peltro (ME13)

### Accessori - Accessories:

#### Bracciolo trapuntato

