

MARENCO

BY MARIO MARENCO

1970



Categorie	Divani, divani componibili, poltrone, pouf.
Struttura	Metallo, multistrato di pioppo e multistrato di betulla.
Molleggio	Schienale cinghie elastiche.
Imbottitura struttura	Poliuretano sagomato a densità differenziata / fibra di poliestere.
Cuscino seduta	Poliuretano sagomato a densità differenziata / fibra di poliestere. Disponibile versione "SOFT"
Piedini	Metallo laccato nero e scivolanti protettivi in nylon nero.
Rivestimento	Tessuto o pelle. Totalmente sfoderabile, ad eccezione della versione in pelle.
Categories	Sofas, seating system, armchairs, pouf.
Structure	Metal, poplar plywood and birch plywood.
Springing	Backrest elastic straps.
Structure upholstery	Shaped polyurethane with differentiated density / polyester slip cover.
Seat cushion	Shaped polyurethane with differentiated density / polyester slip cover. "SOFT" version available.
Feet	Black lacquered metal and black protective nylon glides.
Cover	Fabric or leather. Fully removable cover, except for leather version.
Catégories	Canapés, canapés modulaires, fauteuils, pouf.
Structure	Métal, contreplaqué de peuplier et contreplaqué de bouleau.
Suspension	Dossier sangles élastiques.
Rembourrage structure	Polyuréthane profilé à densité différenciée / fibre polyester.
Coussin d'assise	Polyuréthane profilé à densité différenciée / fibre polyester. Disponible version "SOFT".
Pieds	Métal laqué noir et patins de protection en nylon noir.
Revêtement	Tissu ou cuir. Entièrement déhoussable, sauf pour la version en cuir.
Kategorien	Sofas, abgeteilte Sofas, Sessel, Puff.
Struktur	Metall, Pappelsperrholz und Birkensperrholz.
Federung	Rückenlehne elastische Bänder.
Strukturpolsterung	Geformter Pu-Schaum in unterschiedlicher Dichte / Faserbezug.
Sitzkissen	Geformter Pu-Schaum in unterschiedlicher Dichte / Faserbezug. "SOFT" Version verfügbar.
Füße	Schwarz lackiertes Metall und schwarze schützende Nylonleiter.
Bezug	Stoff oder Leder. Total abziehbar, mit Ausnahme der Lederversion.



Marenco sofa

Elettra armchair – capsule collection *Teddy 02* category *Leather Super*

Goya small table

arflex



Marengo sofa

Match small table

Goya small table



Marengo sofa



Marengo sofa – capsule collection Line 3 category T6

Marengo armchair

Scalea small table

arflex



Marengo armchair



Marengo armchair – capsule collection Tiger 1



Marengo sofa



Marengo sofa



Marengo sofa



Marengo sofa – capsule collection Beat 4
category *Leather Super*



Marenco sofa

Marenco armchair

Delta Vienna armchair

Arcolor small table

Tablet small table



Marengo sofa composition
Marengo pouf
Goya small table





Marengo sofa composition
Goya small table



Marenco *armchair*
Arcolor *small table*





Marengo sofa
Marengo armchair
Tablet small table
Arcolor small table



MARENCO

Poltrone senza braccioli Armchairs without armrests

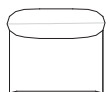
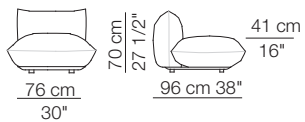

Poltrona con 2 braccioli Armchair with 2 armrests

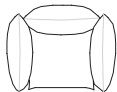
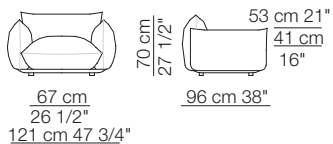

Divani Sofas

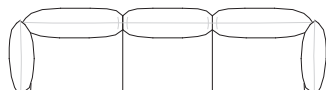
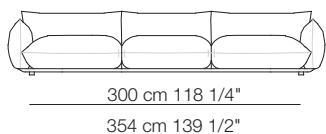
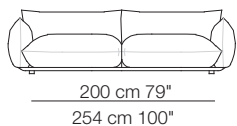
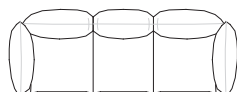
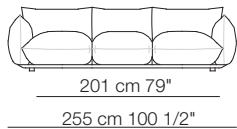
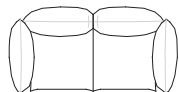
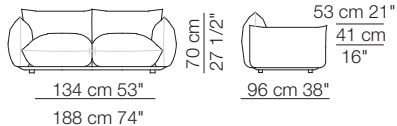

Elementi con 1 bracciolo Units with 1 armrest

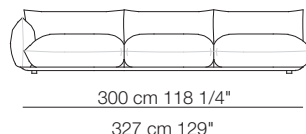
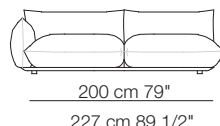
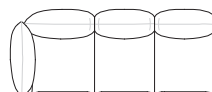
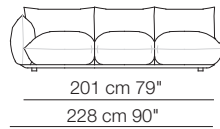
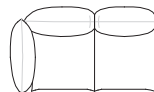
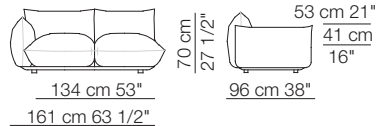

Elementi senza braccioli Units without armrests

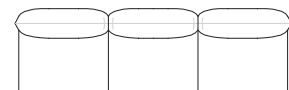
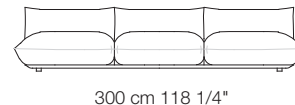
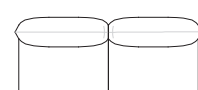
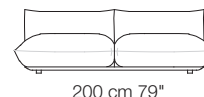
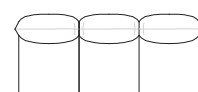
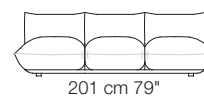
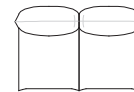
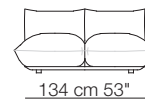

Elementi angolo
Corner units

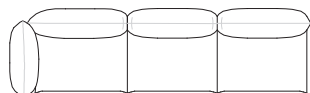
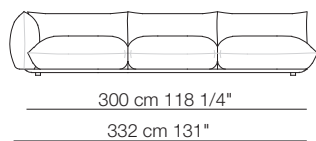
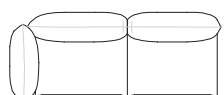
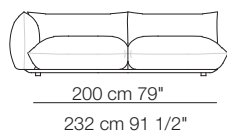
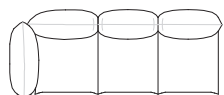
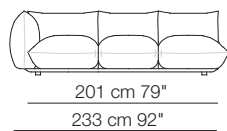
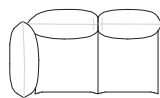
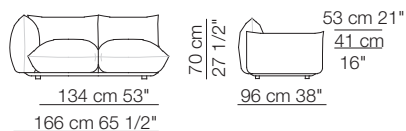

Elementi angolo con 1 bracciolo
Corner units with 1 armrest

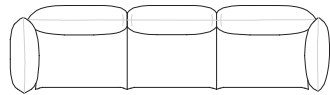
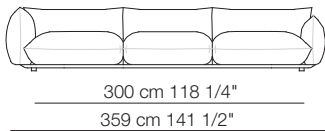
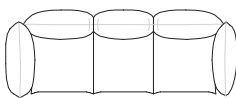
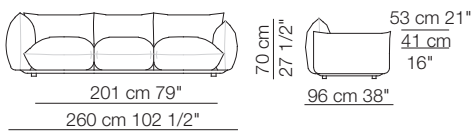

Elementi isola con angolo
Isle units with corner

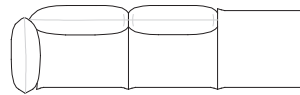
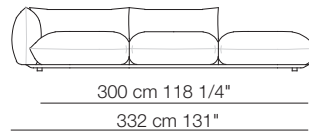
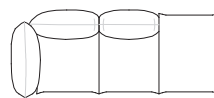
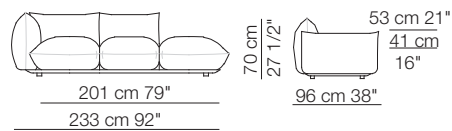

Pouf

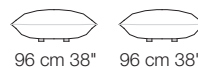
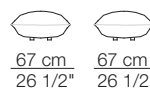

Compositions
Composizioni

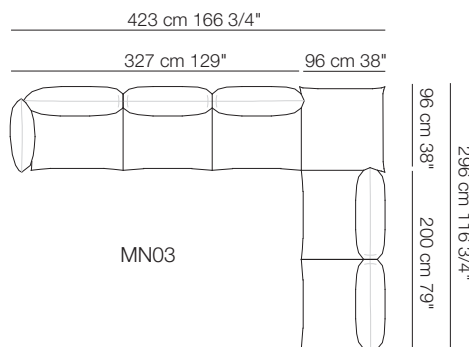
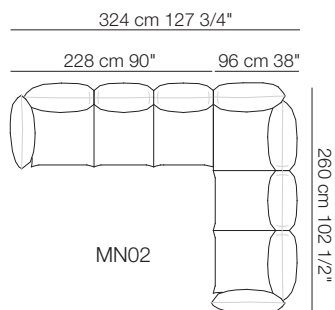
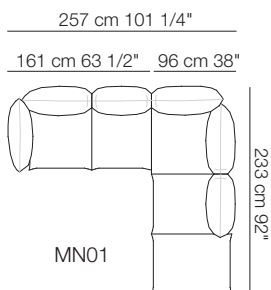

arflex si riserva di apportare ai suoi prodotti, senza alcun preavviso, tutte le modifiche tecniche e strutturali che riterrà opportune, con variazione di dimensioni, pesi e finiture. I colori, le finiture, le illustrazioni e le descrizioni della presente scheda sono a titolo indicativo e non vincolanti. Seven Salotti S.p.A - Tutti i diritti riservati
arflex reserves the right to make all the technical and structural modifications considered appropriate to its models, including variations in dimensions, weights and finished, without giving prior notice. The colours, finishes, illustrations and descriptions in this sheet are only indicative and provided by way of example. Seven Salotti S.p.A. – all rights reserved