

ATELIER ARETI

PRODUCT

Linetype 474
Wall light / Slashes on single tube

MATERIALS AND COLOUR OPTIONS

Brushed brass; white acrylic

VERSIONS

Brass structure; white acrylic 474OL-W01-BR01

TECHNICAL DETAILS

Built in LED tube
Input voltage EU: 230V
Input voltage US: 110V
Output voltage: 24V
2700K
IP20

NOTE

Built in LED light source can be changed by Atelier Areti or a qualified workshop only

MADE IN

Germany

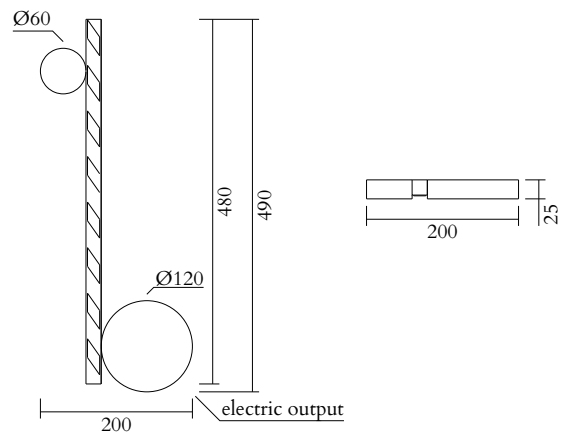
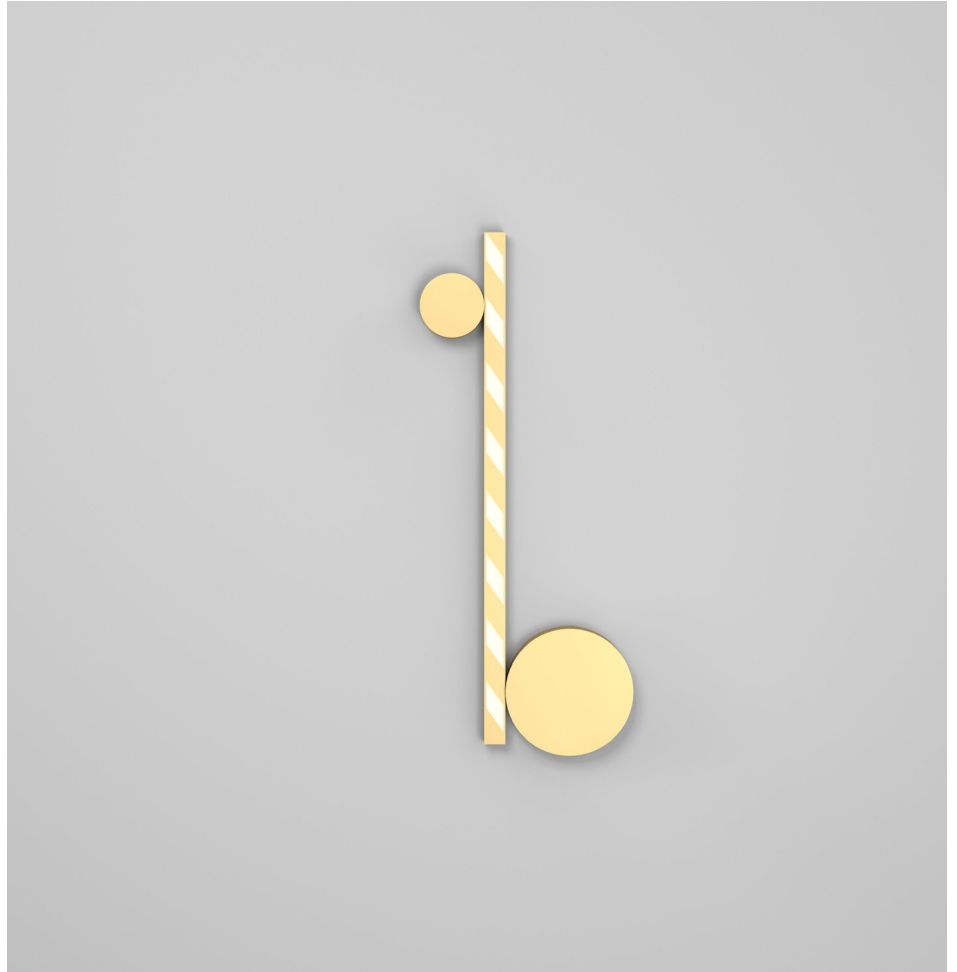

Sizes in mm. Flat attachments available under request. Variations in colour and size are available for some collections, please contact Areti for more details.

Our collections are hand made and made to order, small irregularities in shape or surface will occur, they are inherent to the hand made process and should not be seen as flaws. For detailed information on any products: contact@atelierareti.com

ATELIER ARETI

PRODUCT

Linetype 474
Wall light / Dashes on single tube

MATERIALS AND COLOUR OPTIONS

Brushed brass; white acrylic

VERSIONS

Brass structure; white acrylic 474OL-W02-BR01

TECHNICAL DETAILS

Built in LED tube
Input voltage EU: 230V
Input voltage US: 110V
Output voltage: 24V
2700K
IP20

NOTE

Built in LED light source can be changed by Atelier Areti or a qualified workshop only

MADE IN

Germany

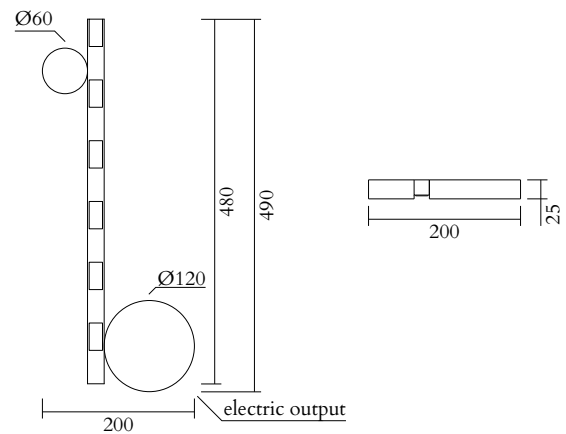
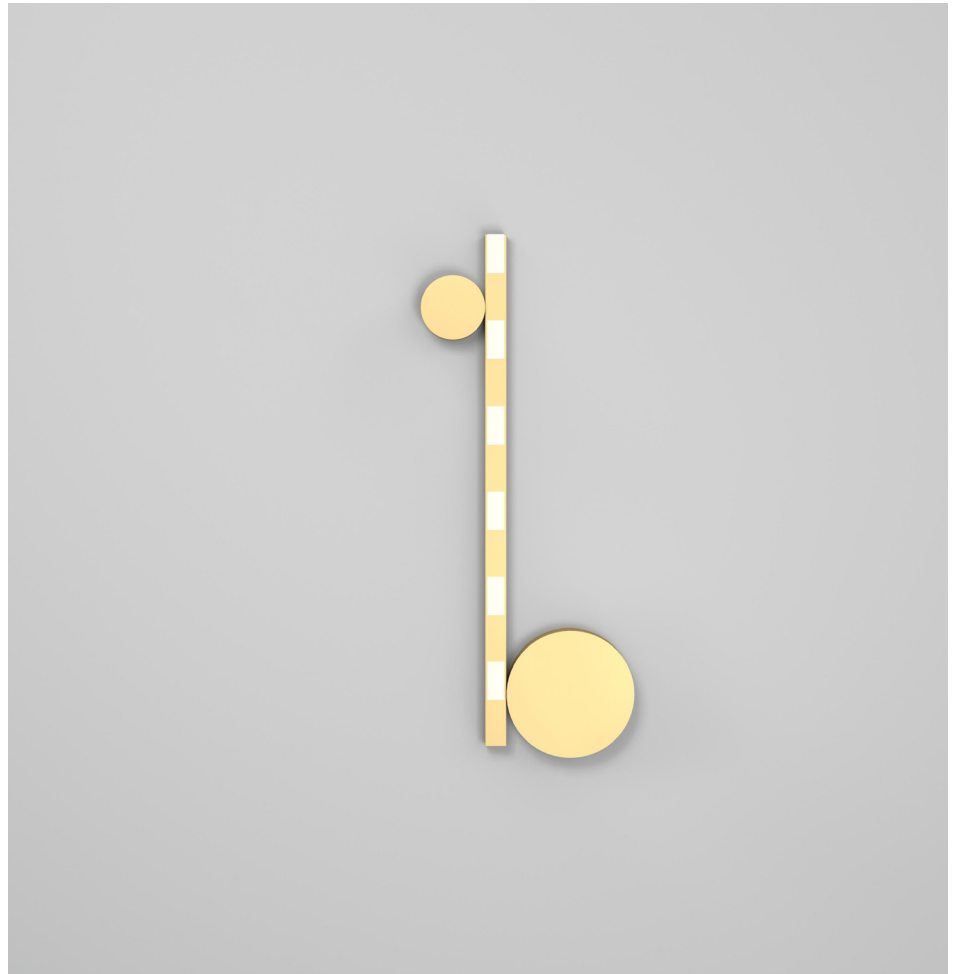

Sizes in mm. Flat attachments available under request. Variations in colour and size are available for some collections, please contact Areti for more details.

Our collections are hand made and made to order, small irregularities in shape or surface will occur, they are inherent to the hand made process and should not be seen as flaws. For detailed information on any products: contact@atelierareti.com

ATELIER ARETI

PRODUCT

Linetype 474
Wall light / Dots on single tube

MATERIALS AND COLOUR OPTIONS

Brushed brass; white acrylic

VERSIONS

Brass structure; white acrylic 474OL-W03-BR01

TECHNICAL DETAILS

Built in LED tube
Input voltage EU: 230V
Input voltage US: 110V
Output voltage: 24V
2700K
IP20

NOTE

Built in LED light source can be changed by Atelier Areti or a qualified workshop only

MADE IN

Germany

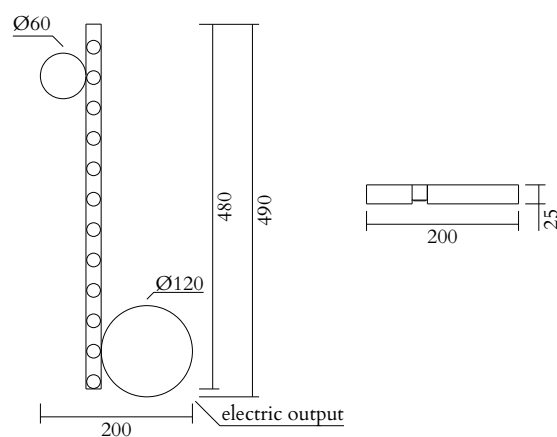
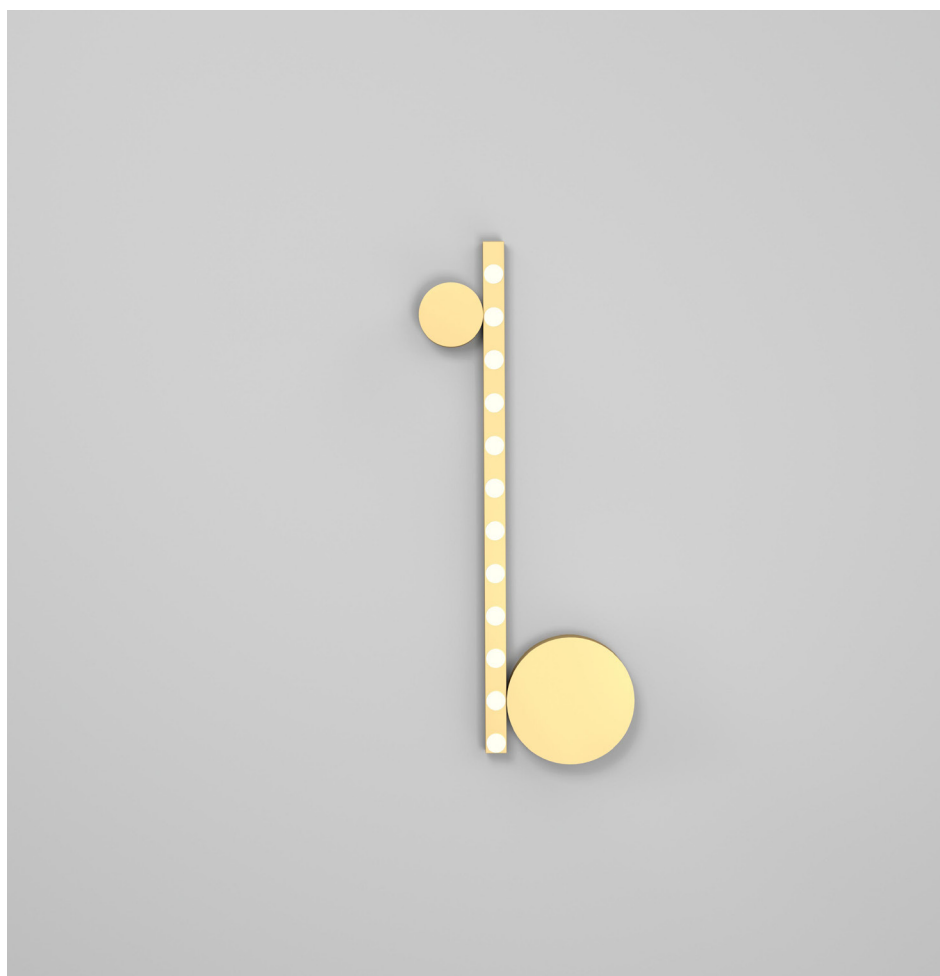

Sizes in mm. Flat attachments available under request. Variations in colour and size are available for some collections, please contact Areti for more details.

Our collections are hand made and made to order, small irregularities in shape or surface will occur, they are inherent to the hand made process and should not be seen as flaws. For detailed information on any products: contact@atelierareti.com

ATELIER ARETI

PRODUCT

Linetype 474

Wall light / Dots + solid + dashes on single tube

MATERIALS AND COLOUR OPTIONS

Brushed brass; white acrylic

VERSIONS

Brass structure; white acrylic 474OL-W04-BR01

TECHNICAL DETAILS

Built in LED tube

Input voltage EU: 230V

Input voltage US: 110V

Output voltage: 24V

2700K

IP20

NOTE

Built in LED light source can be changed by Atelier Areti or a qualified workshop only

MADE IN

Germany

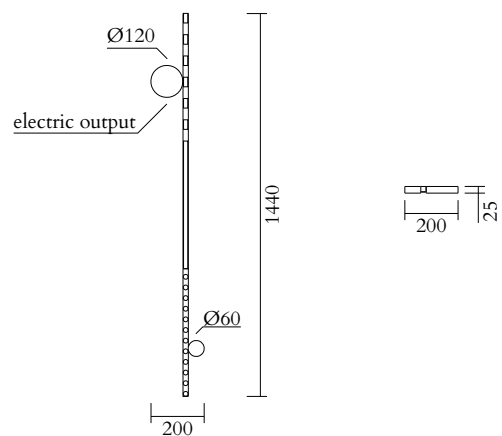

Sizes in mm. Flat attachments available under request. Variations in colour and size are available for some collections, please contact Areti for more details.

Our collections are hand made and made to order, small irregularities in shape or surface will occur, they are inherent to the hand made process and should not be seen as flaws. For detailed information on any products: contact@atelierareti.com

ATELIER ARETI

PRODUCT

Linetype 474
Wall light / Dots + solid on single tube

MATERIALS AND COLOUR OPTIONS

Brushed brass; white acrylic

VERSIONS

Brass structure; white acrylic 474OL-W05-BR01

TECHNICAL DETAILS

Built in LED tube
Input voltage EU: 230V
Input voltage US: 110V
Output voltage: 24V
2700K
IP20

NOTE

Built in LED light source can be changed by Atelier Areti or a qualified workshop only

MADE IN

Germany

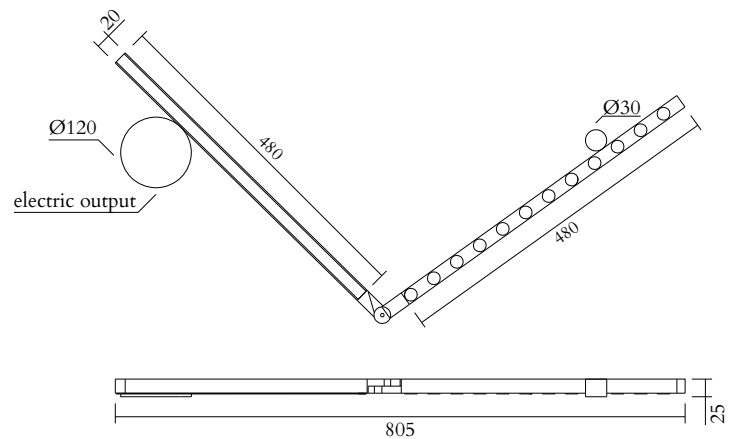

Sizes in mm. Flat attachments available under request. Variations in colour and size are available for some collections, please contact Areti for more details.

Our collections are hand made and made to order, small irregularities in shape or surface will occur, they are inherent to the hand made process and should not be seen as flaws. For detailed information on any products: contact@atelierareti.com

ATELIER ARETI

PRODUCT

Linetype 474
Wall light / Dots + solid + dashes on single tube

MATERIALS AND COLOUR OPTIONS

Brushed brass; white acrylic

VERSIONS

Brass structure; white acrylic 474OL-W06-BR01

TECHNICAL DETAILS

Built in LED tube
Input voltage EU: 230V
Input voltage US: 110V
Output voltage: 24V
2700K
IP20

NOTE

Built in LED light source can be changed by Atelier Areti or a qualified workshop only

MADE IN

Germany

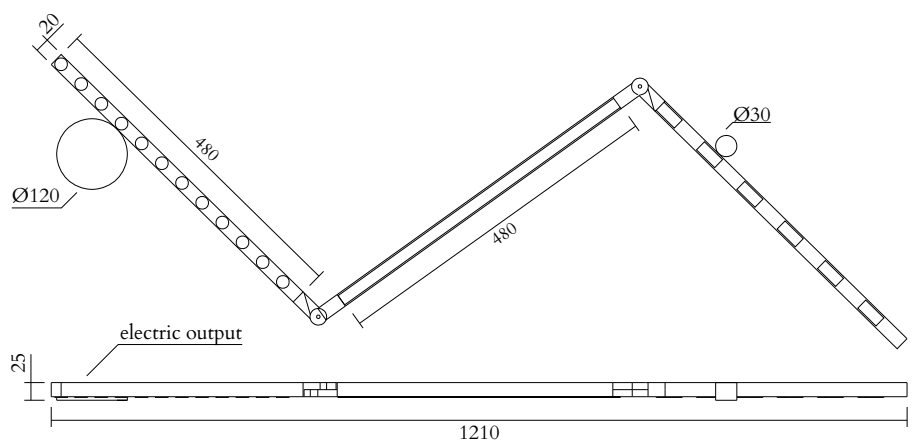

Sizes in mm. Flat attachments available under request. Variations in colour and size are available for some collections, please contact Areti for more details.

Our collections are hand made and made to order, small irregularities in shape or surface will occur, they are inherent to the hand made process and should not be seen as flaws. For detailed information on any products: contact@atelierareti.com