

ATELIER ARETI

PRODUCT

Alouette 004
Ceiling light / 1 Bird 'T'

MATERIALS AND COLOUR OPTIONS

Powder coated metal

VERSIONS

Black structure (white reflector) 004OL-C01-ME01
White structure (white reflector) 004OL-C01-ME02
Colour structure (white reflector) 004OL-C01-ME03
Black structure (brass reflector) 004OL-C01-ME04
White structure (brass reflector) 004OL-C01-ME05
Colour structure (brass reflector) 004OL-C01-ME06

TECHNICAL DETAILS

1 x G9 LED 5W max
110-230V
IP20
Light bulb not included

WEIGHT

6 kg

NOTE

Mirrored bulbs reflect a lot of heat back to the lamp holder. Depending on the space around the lamp holder, the heat might build up above the recommended temperature, especially if the heat is trapped when moving upwards. For this reason, the max. wattage indicated does not apply to mirrored bulbs, but to non mirrored bulbs only. If mirrored bulbs are desired, only those with a low wattage (such as LEDs) should be used. The max. wattage for mirrored bulbs is 5 watt LED (equivalent of 40 watt traditional bulb)

MADE IN

Germany

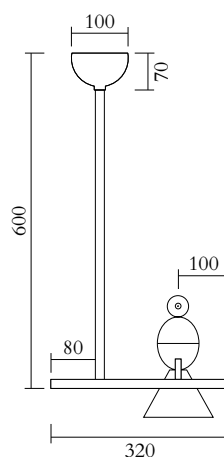

Sizes in mm. Flat attachments available only under request. Variations in colour and size are available for some collections, please contact Areti for more details.

Our collections are hand made and made to order, small irregularities in shape or surface will occur, they are inherent to the hand made process and should not be seen as flaws. For detailed information on any products: contact@atelierareti.com

ATELIER ARETI

PRODUCT

Alouette 004
Ceiling light / 1 Bird 'T'

MATERIALS AND COLOUR OPTIONS

Powder coated metal

VERSIONS

Black structure (white reflector) 004OL-C02-ME01
White structure (white reflector) 004OL-C02-ME02
Colour structure (white reflector) 004OL-C02-ME03
Black structure (brass reflector) 004OL-C02-ME04
White structure (brass reflector) 004OL-C02-ME05
Colour structure (brass reflector) 004OL-C02-ME06

TECHNICAL DETAILS

1 x G9 LED 5W max
110-230V
IP20
Light bulb not included

WEIGHT

6 kg

NOTE

Mirrored bulbs reflect a lot of heat back to the lamp holder. Depending on the space around the lamp holder, the heat might build up above the recommended temperature, especially if the heat is trapped when moving upwards. For this reason, the max. wattage indicated does not apply to mirrored bulbs, but to non mirrored bulbs only. If mirrored bulbs are desired, only those with a low wattage (such as LEDS) should be used. The max. wattage for mirrored bulbs is 5 watt LED (equivalent of 40 watt traditional bulb)

MADE IN

Germany

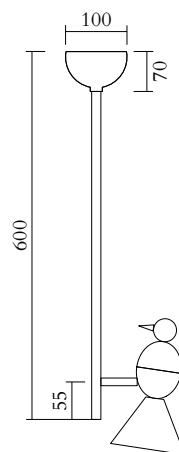

Sizes in mm. Flat attachments available only under request. Variations in colour and size are available for some collections, please contact Areti for more details.

Our collections are hand made and made to order, small irregularities in shape or surface will occur, they are inherent to the hand made process and should not be seen as flaws. For detailed information on any products: contact@atelierareti.com

ATELIER ARETI

PRODUCT

Alouette 004
Ceiling light / 2 Birds 'I'

MATERIALS AND COLOUR OPTIONS

Powder coated metal

VERSIONS

Black structure (white reflector) 004OL-C03-ME01
White structure (white reflector) 004OL-C03-ME02
Colour structure (white reflector) 004OL-C03-ME03
Black structure (brass reflector) 004OL-C03-ME04
White structure (brass reflector) 004OL-C03-ME05
Colour structure (brass reflector) 004OL-C03-ME06

TECHNICAL DETAILS

2 x G9 LED 5W max
110-230V
IP20
Light bulbs not included

WEIGHT

6 kg

NOTE

Mirrored bulbs reflect a lot of heat back to the lamp holder. Depending on the space around the lamp holder, the heat might build up above the recommended temperature, especially if the heat is trapped when moving upwards. For this reason, the max. wattage indicated does not apply to mirrored bulbs, but to non mirrored bulbs only. If mirrored bulbs are desired, only those with a low wattage (such as LEDs) should be used. The max. wattage for mirrored bulbs is 5 watt LED (equivalent of 40 watt traditional bulb)

MADE IN

Germany

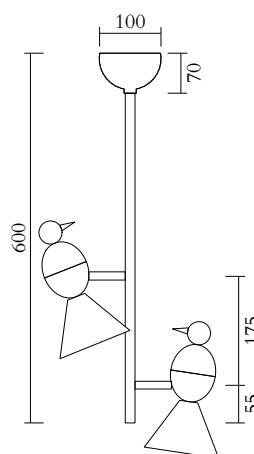

Sizes in mm. Flat attachments available only under request. Variations in colour and size are available for some collections, please contact Areti for more details.

Our collections are hand made and made to order, small irregularities in shape or surface will occur, they are inherent to the hand made process and should not be seen as flaws. For detailed information on any products: contact@atelierareti.com

ATELIER ARETI

PRODUCT

Alouette 004
Ceiling light / 2 Birds 'U'

MATERIALS AND COLOUR OPTIONS

Powder coated metal

VERSIONS

Black structure (white reflector) 004OL-C04-ME01
White structure (white reflector) 004OL-C04-ME02
Colour structure (white reflector) 004OL-C04-ME03
Black structure (brass reflector) 004OL-C04-ME04
White structure (brass reflector) 004OL-C04-ME05
Colour structure (brass reflector) 004OL-C04-ME06

TECHNICAL DETAILS

2 x G9 LED 5W max
110-230V
IP20
Light bulbs not included

WEIGHT

7 kg

NOTE

Mirrored bulbs reflect a lot of heat back to the lamp holder. Depending on the space around the lamp holder, the heat might build up above the recommended temperature, especially if the heat is trapped when moving upwards. For this reason, the max. wattage indicated does not apply to mirrored bulbs, but to non mirrored bulbs only. If mirrored bulbs are desired, only those with a low wattage (such as LEDs) should be used. The max. wattage for mirrored bulbs is 5 watt LED (equivalent of 40 watt traditional bulb)

MADE IN

Germany

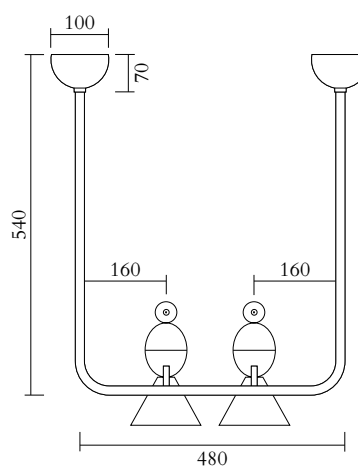

Sizes in mm. Flat attachments available only under request. Variations in colour and size are available for some collections, please contact Areti for more details.

Our collections are hand made and made to order, small irregularities in shape or surface will occur, they are inherent to the hand made process and should not be seen as flaws. For detailed information on any products: contact@atelierareti.com

ATELIER ARETI

PRODUCT

Alouette 004
Ceiling light / 3 Birds 'U'

MATERIALS AND COLOUR OPTIONS

Powder coated metal

VERSIONS

Black structure (white reflector) 004OL-C05-ME01
White structure (white reflector) 004OL-C05-ME02
Colour structure (white reflector) 004OL-C05-ME03
Black structure (brass reflector) 004OL-C05-ME04
White structure (brass reflector) 004OL-C05-ME05
Colour structure (brass reflector) 004OL-C05-ME06

TECHNICAL DETAILS

3 x G9 LED 5W max
110-230V
IP20
Light bulbs not included

WEIGHT

8 kg

NOTE

Mirrored bulbs reflect a lot of heat back to the lamp holder. Depending on the space around the lamp holder, the heat might build up above the recommended temperature, especially if the heat is trapped when moving upwards. For this reason, the max. wattage indicated does not apply to mirrored bulbs, but to non mirrored bulbs only. If mirrored bulbs are desired, only those with a low wattage (such as LEDs) should be used. The max. wattage for mirrored bulbs is 5 watt LED (equivalent of 40 watt traditional bulb)

MADE IN

Germany

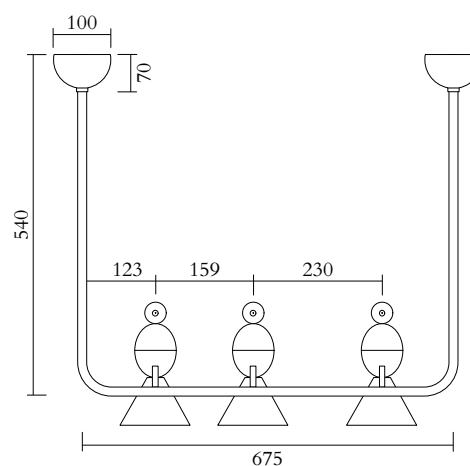

Sizes in mm. Flat attachments available only under request. Variations in colour and size are available for some collections, please contact Areti for more details.

Our collections are hand made and made to order, small irregularities in shape or surface will occur, they are inherent to the hand made process and should not be seen as flaws. For detailed information on any products: contact@atelierareti.com

ATELIER ARETI

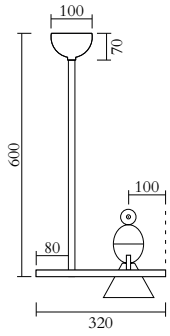

Alouette Pendant 1 Bird 'T'
004OL-C01

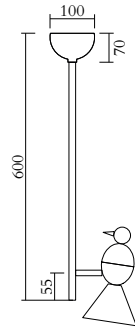

Alouette Pendant 1 Bird 'I'
004OL-C02

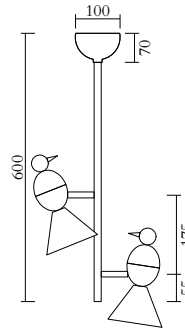

Alouette Pendant 2 Birds 'I'
004OL-C03

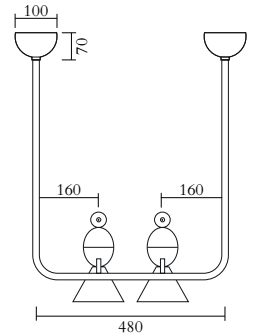

Alouette Pendant 2 Birds 'U'
004OL-C04

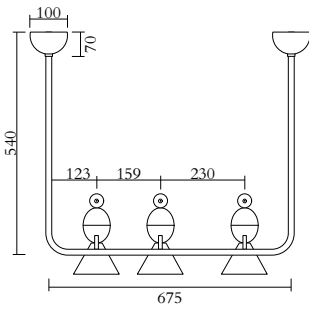

Alouette Pendant 3 Birds 'U'
004OL-C05

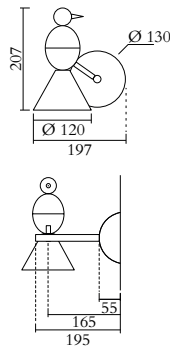

Alouette Wall
004OL-W01

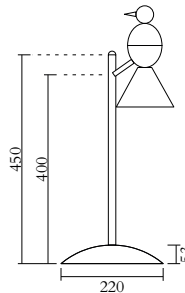

Alouette Desk / straight
004OL-D01

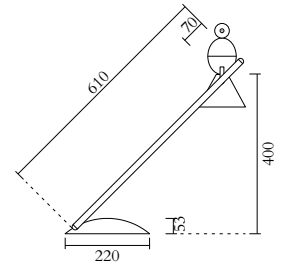

Alouette Desk / slanted
004OL-D02

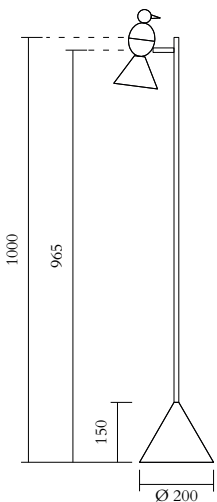

Alouette Floor 1 bird
004OL-F01

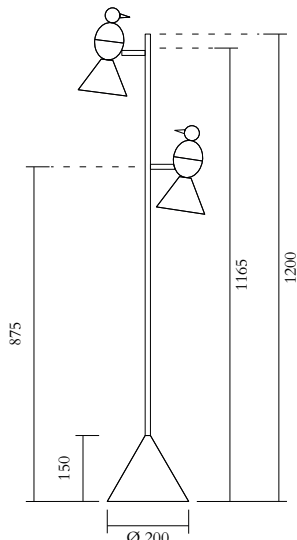

Alouette Floor 2 birds
004OL-F02

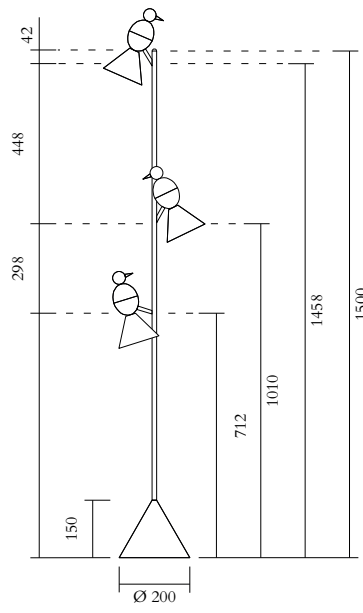

Alouette Floor 3 birds
004OL-F03

