

SISTEMA PARERE 1

AM044

Design by
Emanuel Gargano & Anton Cristell - 2015

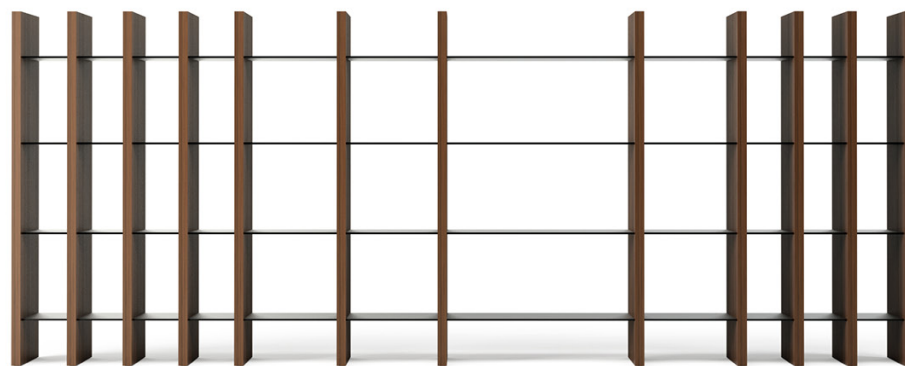

ITA

Una libreria che lascia grande spazio all'immaginazione e alla possibilità di personalizzare l'interior design di ogni ambiente, dalla zona living di casa, allo studio professionale, dalle aree comuni di un hotel, a una business lounge. Parere è la libertà di esprimere la propria visione dello spazio e di giocare con diversi moduli e un'infinita possibilità di configurazioni. Una sorta di "fisarmonica" che si adatta in larghezza alle varie esigenze abitative e può essere utilizzata come libreria tradizionale, ma anche come parete divisoria per creare due ambienti da un unico spazio. Sintesi di design e funzionalità, in Parere si esprime il contrasto fra elementi verticali ed elementi orizzontali.

EN

A library leaving great space to imagination, and to the possibility to customize the interior design of any ambient, from the living room to the professional study, the public areas of hotels, a business lounge. Parere is the freedom to express one's own vision of space, and to play with different modules and an infinite range of configurations. A sort of "accordion", getting wider or narrower according to the living needs and that can be used as a traditional bookshelf, but also as a partition that creates two ambient from a single room. A synthesis of design and functionality, Parere expresses in itself the contrast between vertical elements and the horizontal elements.

Informazioni tecniche Technical information

STRUTTURA: LEGNO SPESSORE 4 CM H 160 O 240 CM
RIPIANI: LAMIERA METALLICA SPESSORE 8 MM, ALL'INTERNO DEI VANI CONTENITORI I RIPIANI SONO DISPONIBILI SOLO IN LEGNO SPESSORE 40 MM
SCHIENALE: LEGNO SPESSORE FINO A 40 MM
ANTE: DISPONIBILI IN LEGNO, VETRO, PELLE E CUIO LO SPESSORE VARIA IN BASE AL MATERIALE SCELTO
ACCESSORI: CERNIERE O KIT VASISTAS PER ANTE E PASSACAVI

STRUCTURE: WOOD 4 CM THICK, HEIGHT 160 OR 240 CM
SHELVES: METAL SHEET 8 MM THICK, INSIDE THE STORAGE THE SHELVES ARE AVAILABLE ONLY IN WOOD 40 MM THICK
BACK: WOOD THICK UP TO 40 MM
DOORS: AVAILABLE IN WOOD, GLASS, LEATHER AND CUIO, THE THICKNESS MAY VARY ACCORDING TO THE SELECTED MATERIALS
ACCESSORIES: HINGES OR VASISTAS KIT FOR DOORS AND FAIRLEAD



È POSSIBILE MODIFICARE LE DIMENSIONI DEL PRODOTTO ENTRO UN MASSIMO DI 20 CM, CON UN SOVRAPPREZZO DEL 20% SUL PREZZO DI LISTINO. | ANY MODIFICATION IN SIZE IS AVAILABLE ON THIS PRODUCT, WITHIN A 20CM RANGE, WITH A 20% SURCHARGE.

È RESPONSABILITÀ DELL'ACQUIRENTE VERIFICARE CHE IL PRODOTTO SIA IDONEO E CONFORME AI REQUISITI RICHIESTI, PER LA DESTINAZIONE D'USO E ALLE NORMATIVE VIGENTI NEL LUOGO DI DESTINAZIONE E UTILIZZO DEL PRODOTTO | IT'S THE ACQUIRER'S RESPONSIBILITY TO VERIFY THAT THE PRODUCT IS SUITABLE AND IN COMPLIANCE WITH THE REQUIREMENTS, FOR THE INTENDED USE AND WITH THE REGULATIONS IN FORCE AT THE PLACE OF DESTINATION AND USE OF THE PRODUCT

*1 MODULI NON SONO VENDIBILI SINGOLARMENTE, MA UTILI A CREARE COMPOSIZIONI PERSONALIZZABILI | THE MODULES CANNOT BE SOLD SEPARATELY, THEY ARE USEFUL IN CREATING CUSTOMIZABLE COMPOSITIONS

Finiture disponibili Available finishes



Consigliato da Amura Suggested by Amura

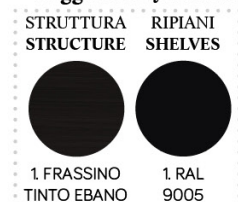

• PER ALCUNE FINITURE SONO DISPONIBILI ALTRE VARIANTI DI COLORE | FOR SOME FINISHES OTHER COLOR OPTIONS ARE AVAILABLE.

• AL LINK DI SEGUITO È DISPONIBILE UNA SELEZIONE DI FINITURE E RIVESTIMENTI SU RICHIESTA, CON TEMPI E PREZZI DIFFERENTI RISPETTO AI MATERIALI SOPRA INDICATI | AT THE FOLLOWING LINK IS AVAILABLE ON REQUEST, A SELECTION OF FINISHES AND COVERAGES WITH DIFFERENT PRICES AND PRODUCTION TIMES COMPARED TO THE MATERIALS SHOWN ABOVE. <https://amuralab.com/en/special-materials/>

Dimensioni Dimension

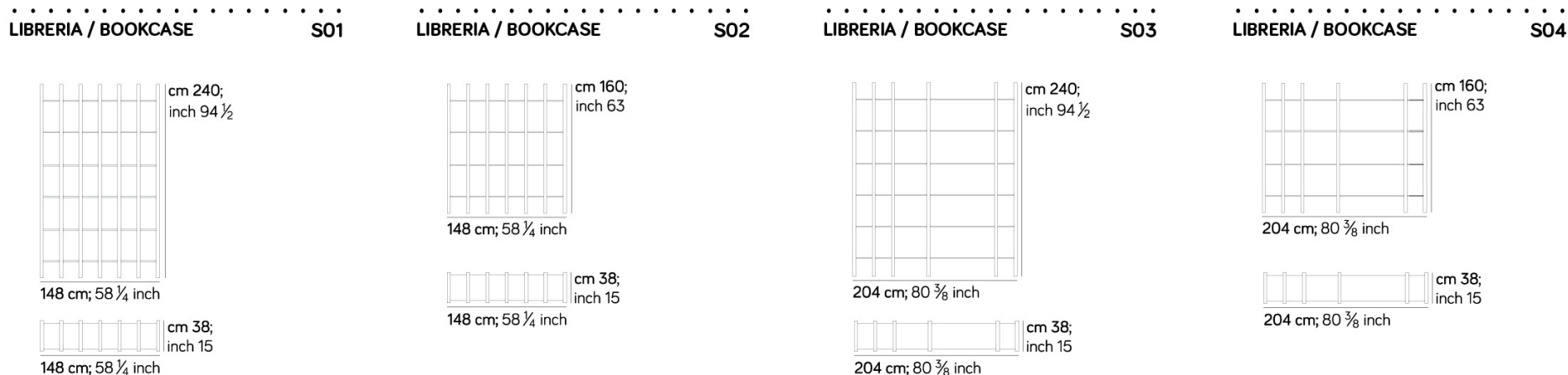



LIBRERIA / BOOKCASE

S05

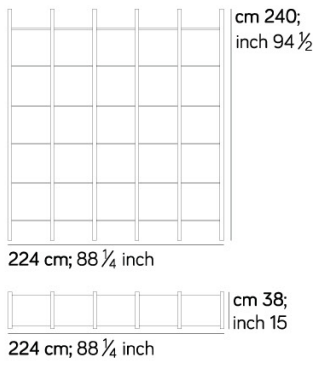

LIBRERIA / BOOKCASE

S06

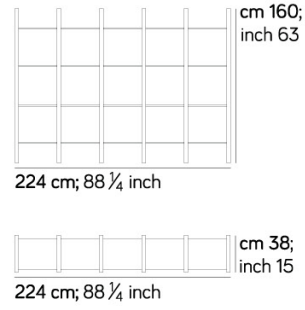

LIBRERIA / BOOKCASE

S07

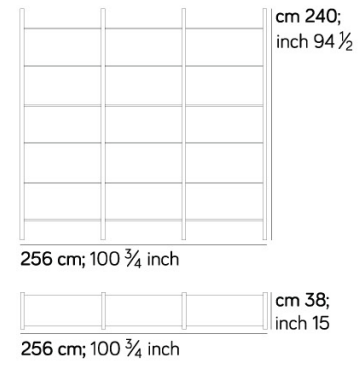

LIBRERIA / BOOKCASE

S08

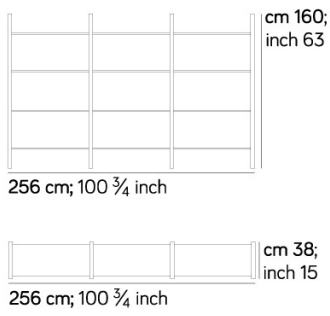

LIBRERIA / BOOKCASE

S09

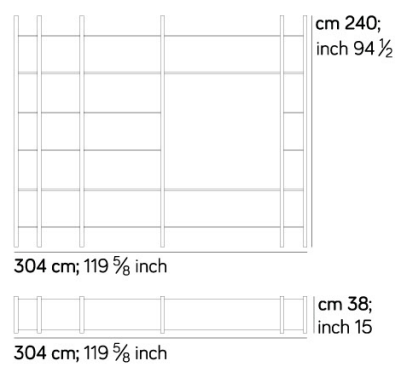

LIBRERIA / BOOKCASE

S10

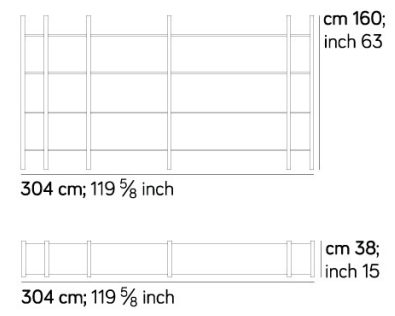

LIBRERIA / BOOKCASE

S11

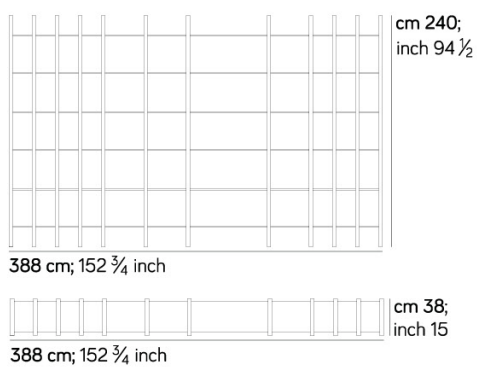

LIBRERIA / BOOKCASE

S12

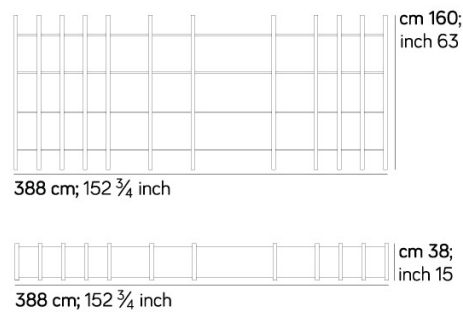

LIBRERIA / BOOKCASE

S13

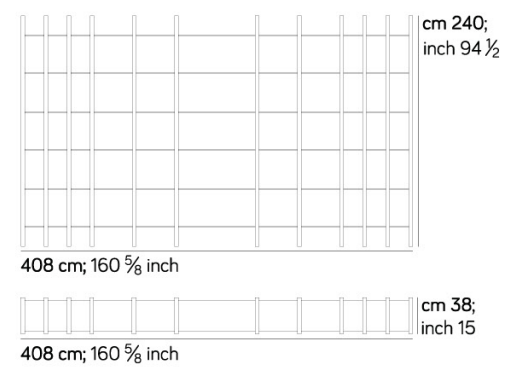

LIBRERIA / BOOKCASE

S14

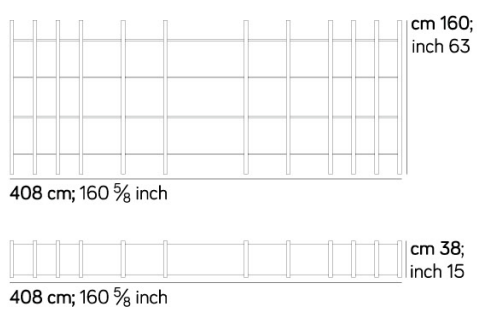

LIBRERIA / BOOKCASE

S15

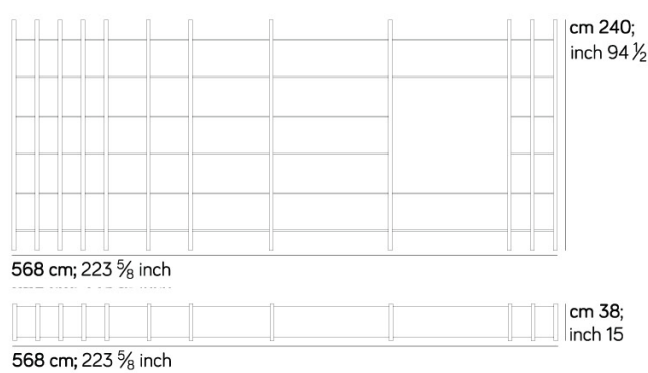

LIBRERIA / BOOKCASE

S16

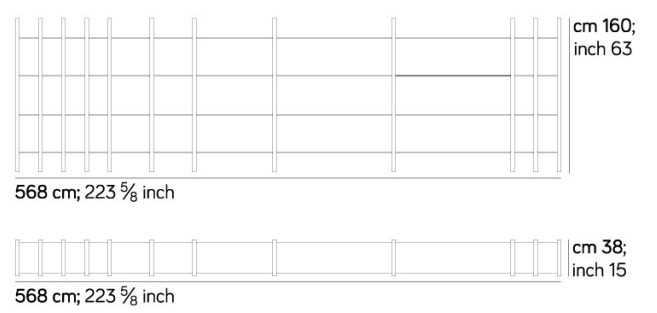

LIBRERIA / BOOKCASE

S17

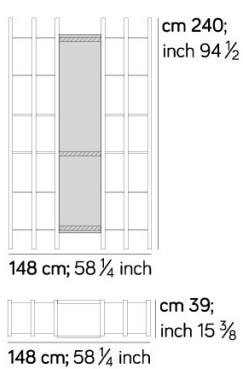

LIBRERIA / BOOKCASE

S18

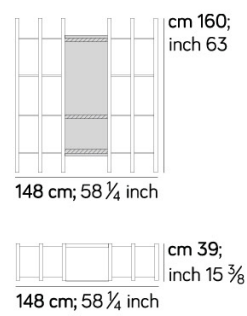

LIBRERIA / BOOKCASE

S19

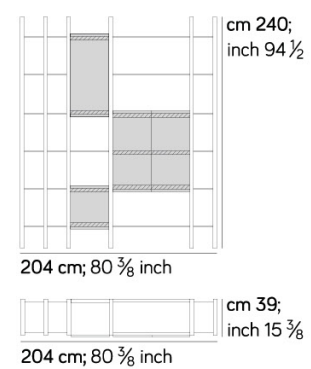



LIBRERIA / BOOKCASE

S20

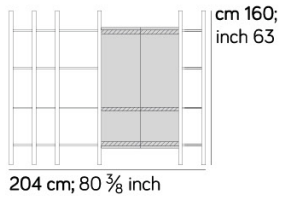

204 cm; 80 3/8 inch



204 cm; 80 3/8 inch

LIBRERIA / BOOKCASE

S21

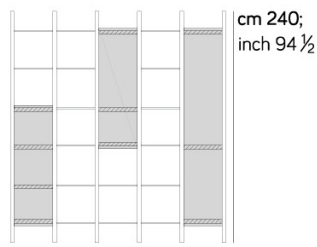

224 cm; 88 1/4 inch



224 cm; 88 1/4 inch

LIBRERIA / BOOKCASE

S22

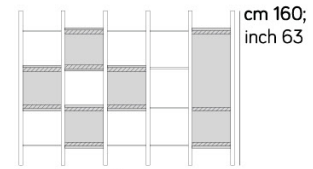

224 cm; 88 1/4 inch



224 cm; 88 1/4 inch

LIBRERIA / BOOKCASE

S23

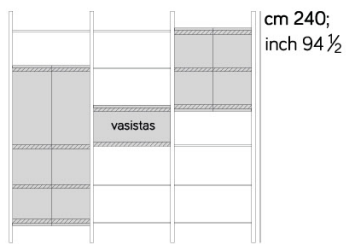

256 cm; 100 3/4 inch



256 cm; 100 3/4 inch

LIBRERIA / BOOKCASE

S24

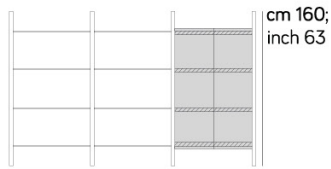

256 cm; 100 3/4 inch



256 cm; 100 3/4 inch

LIBRERIA / BOOKCASE

S25

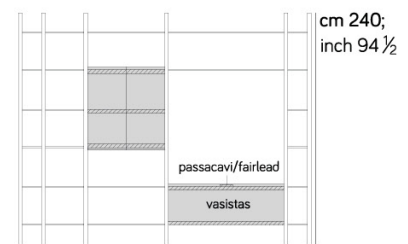

304 cm; 119 5/8 inch



304 cm; 119 5/8 inch

LIBRERIA / BOOKCASE

S26

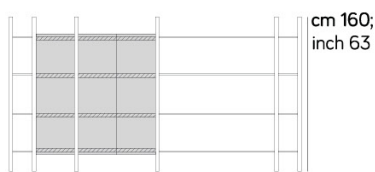

304 cm; 119 5/8 inch



304 cm; 119 5/8 inch

LIBRERIA / BOOKCASE

S27

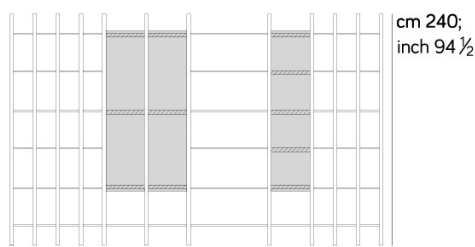

388 cm; 152 3/4 inch

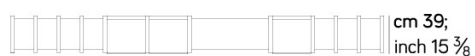

388 cm; 152 3/4 inch

LIBRERIA / BOOKCASE

S28

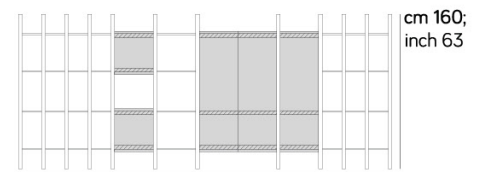

388 cm; 152 3/4 inch



388 cm; 152 3/4 inch

LIBRERIA / BOOKCASE

S29

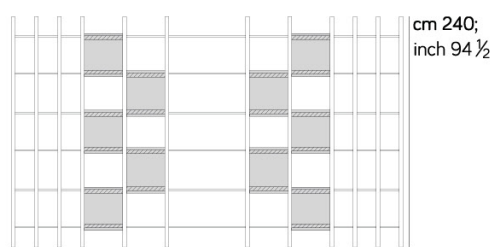

408 cm; 160 5/8 inch



408 cm; 160 5/8 inch

LIBRERIA / BOOKCASE

S30

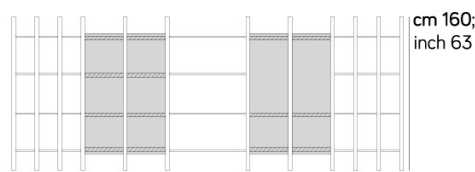

408 cm; 160 5/8 inch



408 cm; 160 5/8 inch

LIBRERIA / BOOKCASE

S31

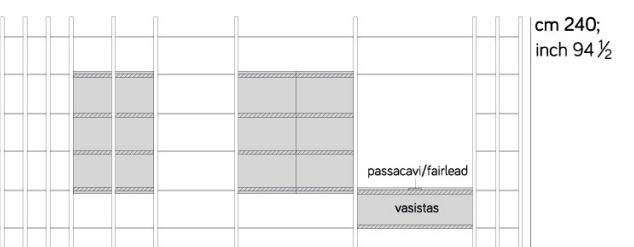

568 cm; 223 5/8 inch



568 cm; 223 5/8 inch

LIBRERIA / BOOKCASE

S32

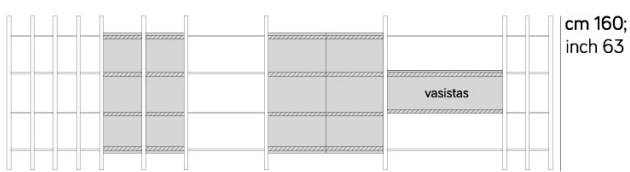

568 cm; 223 5/8 inch



568 cm; 223 5/8 inch

LIBRERIA / BOOKCASE

S33

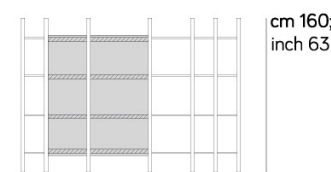

228 cm; 89 3/4 inch



228 cm; 89 3/4 inch

LIBRERIA / BOOKCASE

S34

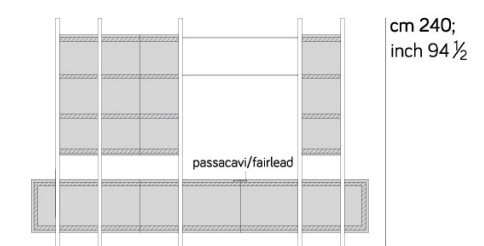

350 cm; 137 3/4 inch



350 cm; 137 3/4 inch



STRUTTURA / STRUCTURE F240

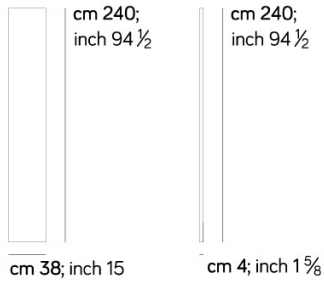

STRUTTURA / STRUCTURE F160

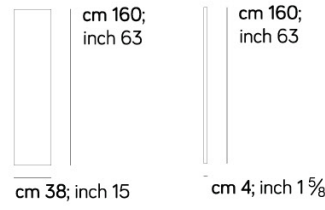

MODULO TERMINALE / TERMINAL MODULE MOD F1

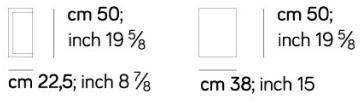

MODULO TERMINALE / TERMINAL MODULE MOD F2

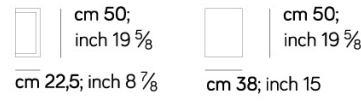

MENSOLA / SHELF SH 20

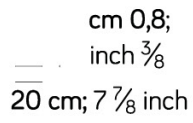

MENSOLA / SHELF SH 40

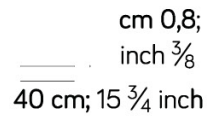

MENSOLA / SHELF SH 60

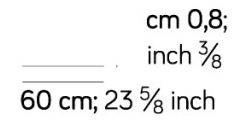

MENSOLA / SHELF SH 80

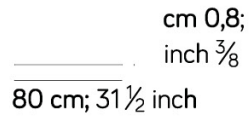

MENSOLA / SHELF SH 120

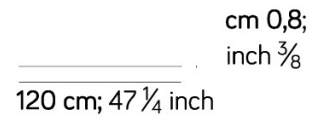

MENSOLA / SHELF SH 160

