

NEBULA SEAT

by e-ggs

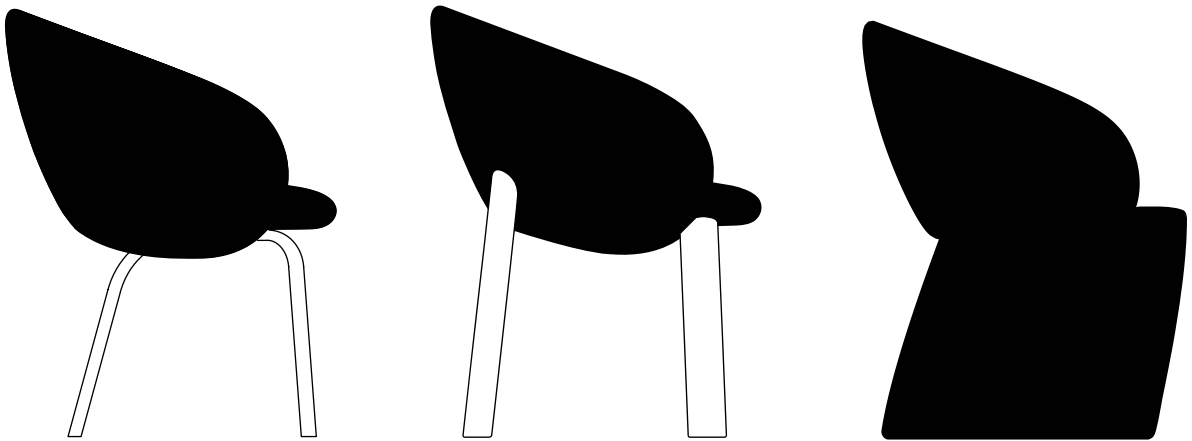

Nebula è scesa dallo Spazio per raccontarci la sua estetica: un design denso e avvolgente, alleggerito da linee slanciate verso il blu. Assume così la consistenza di una nuvola, capace di trasformarsi restando riconoscibile: i due braccioli a goccia caratterizzano la linea composta da sedia, poltroncina e lounge, ognuna con differenti tipologie di basi per adattarsi ad ogni tipo di atterraggio. In più la scocca che la compone è realizzata esclusivamente in poliuretano, un materiale totalmente riciclabile. Spaziale, no?

Nebula came down from Space to bring us its aesthetic: a dense, enveloping design, lightened by sleek lines that reach for the sky. Thus it seems to take on the consistency of a cloud, transforming with ease, all the while maintaining a clear and recognisable identity: the two teardrop arms are a key feature of the seat, armchair and lounge chair, each with different types of bases suitable to land anywhere. In addition, its shell is made exclusively of polyurethane, a fully recyclable material. Out of this world, right?.

DIMENSIONI | DIMENSIONS

NEBULA TUBE

lunghezza | width: 66 cm
larghezza | depth: 62 cm
altezza | height: 80 cm
altezza del sedile | seat height: 48 cm

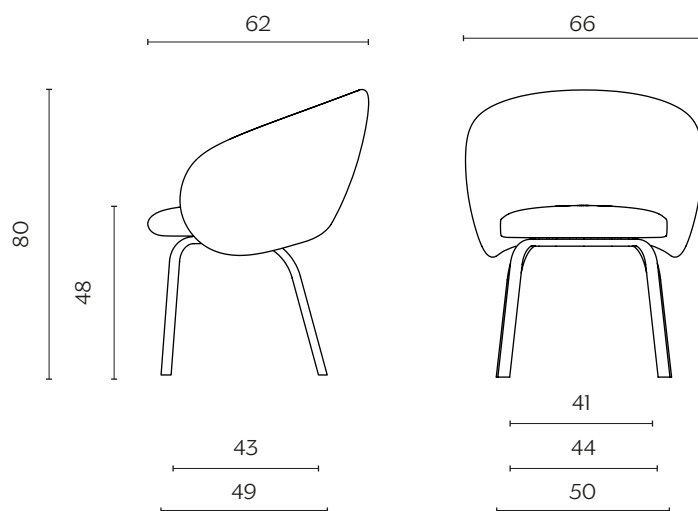

NEBULA WOOD

lunghezza | width: 66 cm
larghezza | depth: 62 cm
altezza | height: 80 cm
altezza del sedile | seat height: 48 cm

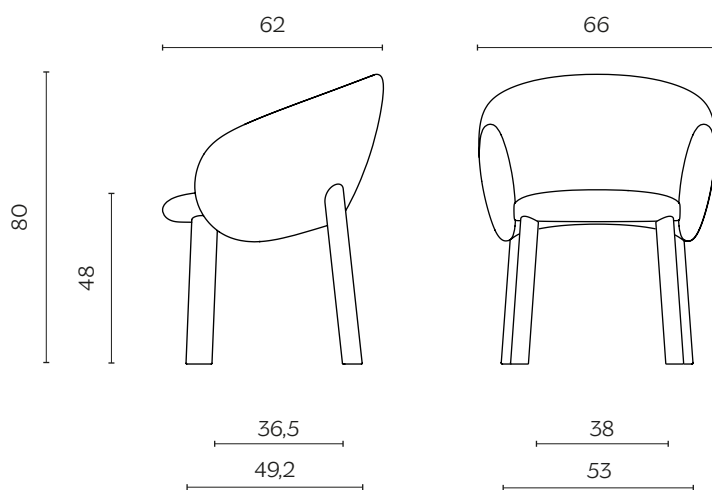

DIMENSIONI | DIMENSIONS

NEBULA MONACA

lunghezza | width: 66 cm

larghezza | depth: 62 cm

altezza | height: 80 cm

altezza del sedile | seat height: 48 cm

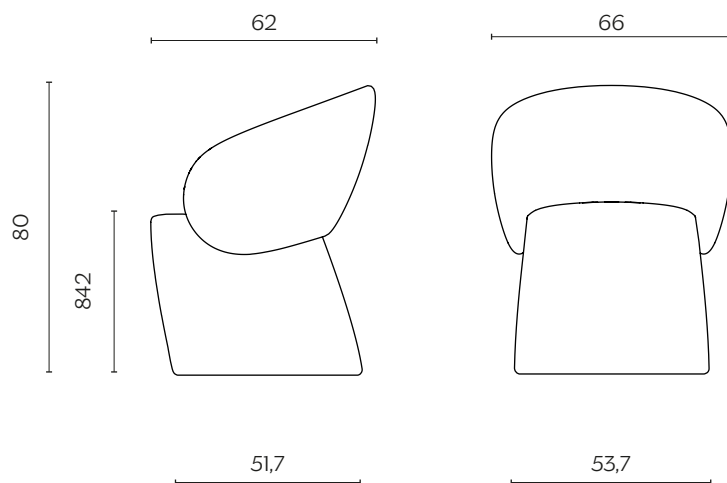

FINITURE GAMBE | LEGS FINISHES

LEGNO | WOOD



Frassino
Ash



Frassino nero
Black ash

METALLO | METAL

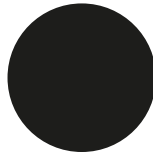

Nero
Black

TESSUTI | FABRICS

A

LOOP

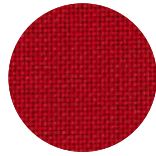

Rosso

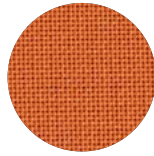

Arancione



Blu notte



Cioccolato



Burro

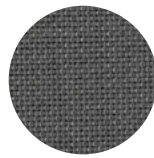

Grigio fumo



Nero

TRAMÈ

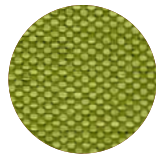

Mela

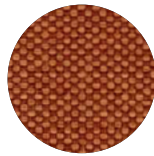

Arancio



Uva



Nero



Beige

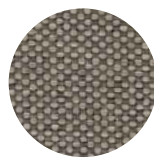

Tortora

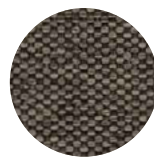

Grigio scuro

TESSUTI | FABRICS

A

CANVA

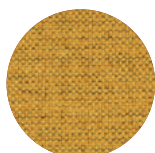

Ciallo

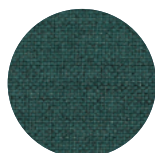

Petrolio

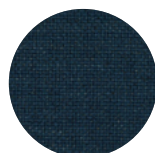

Blu

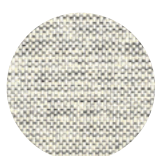

Sale

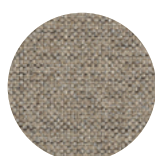

Sabbia

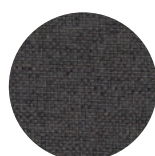

Grigio scuro

PEPLO



Cannella



Rosso mattone

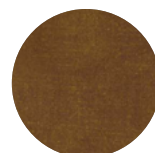

Giallo ocra



Grigio chiaro

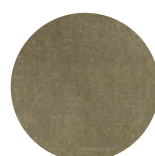

Grigio tortora



Blu notte

TESSUTI | FABRICS

B

VESCOM WILSON

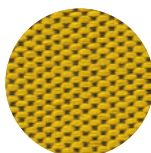

Ciallo elettrico

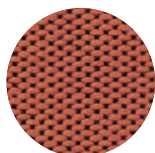

Rosé

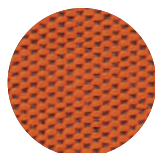

Energico

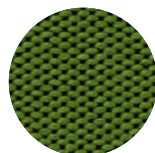

Laguna

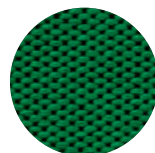

Prato

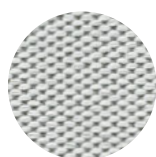

Neve

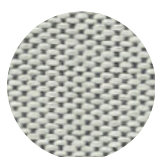

Sale e pepe

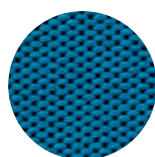

Zaffiro

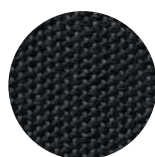

Crafite

VESCOM NORFOLK

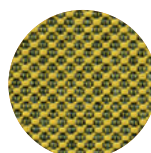

Ape

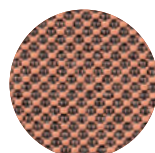

Rosa

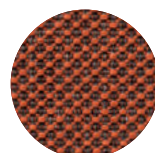

Mattone

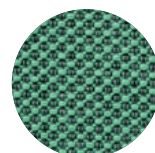

Latte e menta

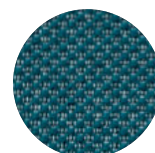

Petrolio

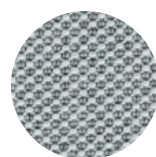

Chiaccio



Sale e pepe



Notte



Antracite

TESSUTI | FABRICS

C

KVADRAT RELATE

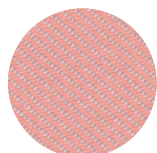

Rosa

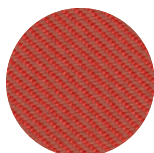

Rosso

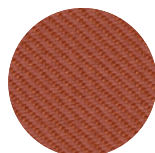

Terra



Snack

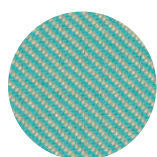

Menta



Verde bosco



Nuvolo

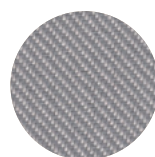

Grigio

KVADRAT FIELD 2

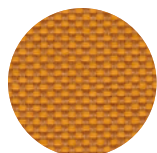

Zafferano

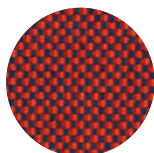

Ciliegia

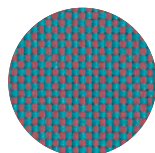

Zucchero

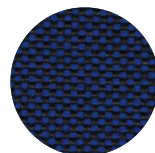

Blu

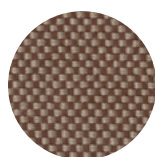

Nocciola

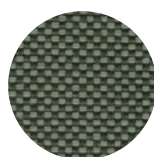

Menta

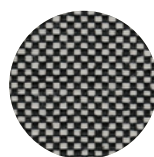

Sale e pepe

TESSUTI | FABRICS

C

VESCOM HARDING

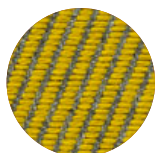

Ciallo

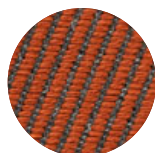

Rosso

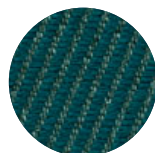

Petrolio

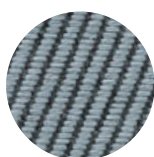

Nuvolo



Crigio chiaro

VESCOM ROLLA



Mostarda

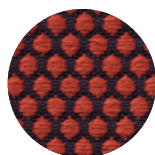

Ciliegia

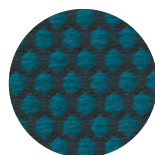

Blu pavone



Latte

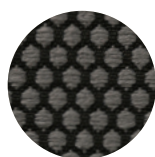

Crafite

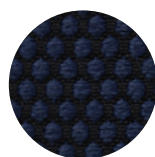

Blu notte

TESSUTI | FABRICS

C

VESCOM MOORE

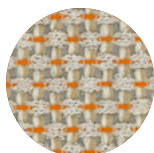

Margherita

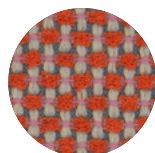

Lampone

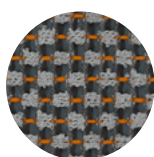

Saetta

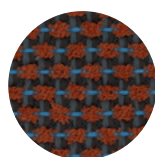

Uva

TORRILANA GUBBIO

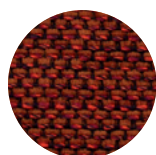

Ambra

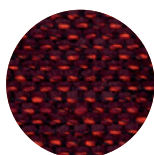

Bordeaux

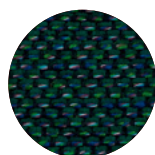

Verde Petrolio

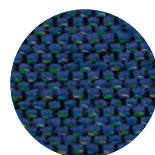

Blu elettrico

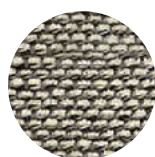

Sale e pepe

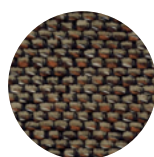

Castagna



Tortora

TESSUTI | FABRICS

C

BIG BOSS



Nuvola

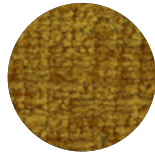

Senape



Nocciola

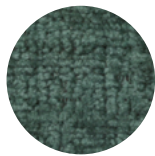

Turchese

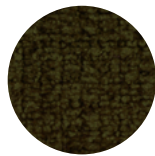

Muschio



Porpora

MAHARAM METRIC

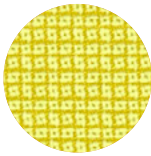

Canary

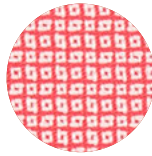

Cala

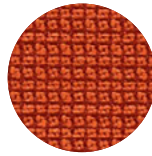

Lava

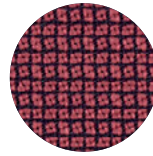

Kiln

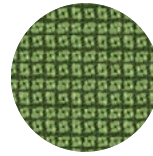

Alligator

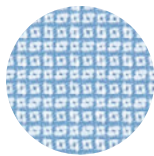

Middy

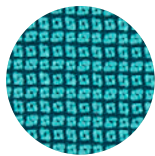

Talisman

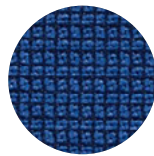

Seaport

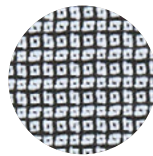

Film

TESSUTI | FABRICS

D

MAHARAM MERIT



Salmone

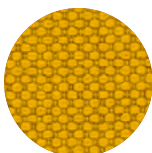

Ciallo

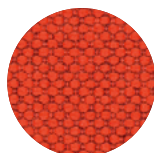

Rosso corallo

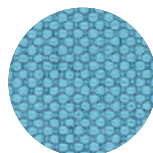

Celeste



Marrone

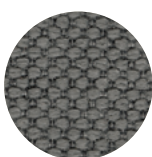

Grigio



Sale e pepe

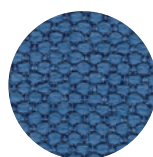

Blu cobalto

ROHI SERA

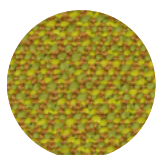

Tivoli

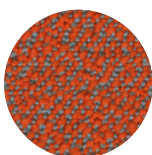

Glow

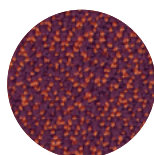

Berry

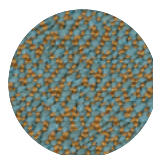

Mirage

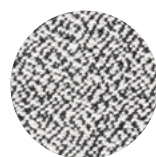

Pepper

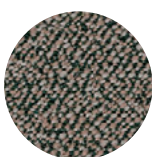

Walnut



Rosewood

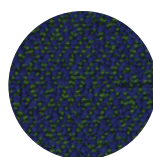

Mare

TESSUTI | FABRICS

D

ROHI MICA

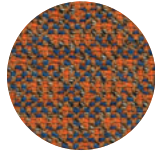

Sanddorn

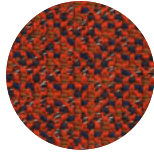

Indio

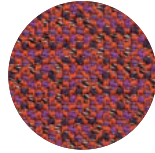

Brevia

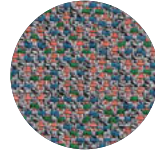

Papillon

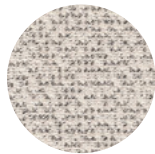

Calla

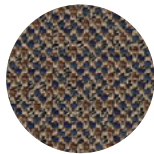

Crisp

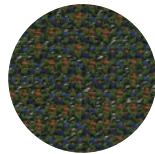

Jungle

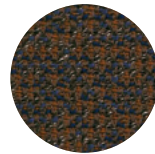

Secret

ROHI CLEO

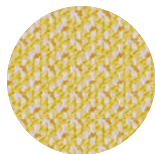

Lemon

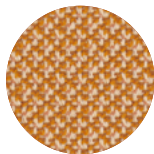

Peach

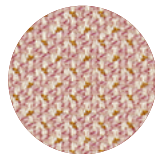

Flamingo

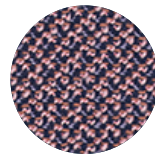

Azalee

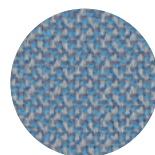

Sky

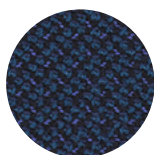

Ocean

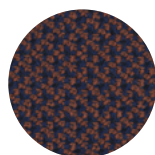

Magma

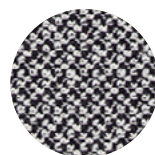

Pepper

TESSUTI | FABRICS

D

ERIMITI CLOUD



Panna



Noce



Nocciola



Bordeaux

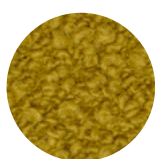

Senape

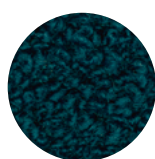

Petrolio



Blu notte

TORRILANA BRIONNE

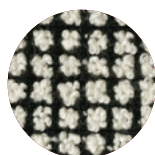

Black and white

TESSUTI | FABRICS

E

KVADRAT STEEL CUT TRIO 3

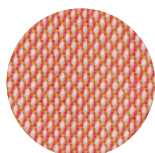

Pesca

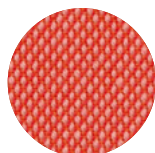

Arancia rossa

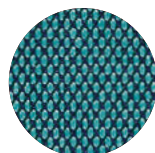

Pavone

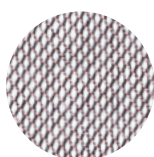

Sale e pepe

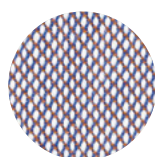

Elettricità

DEDAR SANSONE

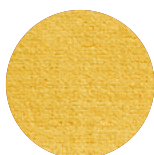

Torunesol



Zucca



Persia



Cactus



Havane



Champagne



Terre d'ombre



Ebano



Encre

TESSUTI | FABRICS

E

DEDAR VOULEZ-VOUS

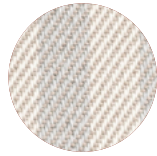

Sambuco



Cirasole

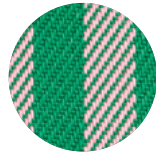

Fragola e menta



Tiramisu

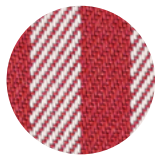

Amarena



Tabacco



Noce di cocco

TESSUTI | FABRICS

F

KVADRAT SUUNTA

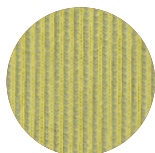

Primavera



Narcis

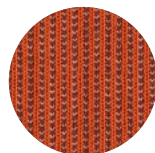

Tulip

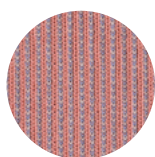

Peony

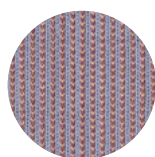

Crocus

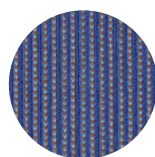

Iris

KVADRAT TERO OUT



Sole



Verde prato



Borgogna



Notte



Panna



Nuvole

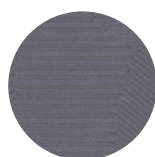

Robot



Tabacco

TESSUTI | FABRICS

F

MAHARAM OXBOW

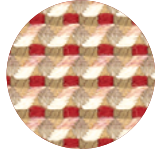

Dianthus

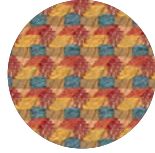

Montage

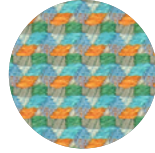

Nouveau

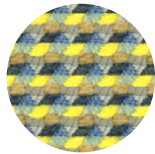

Legume

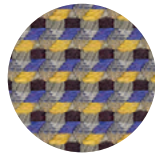

Module

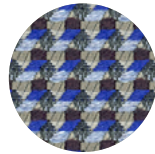

Trope

SAHCO ZERO

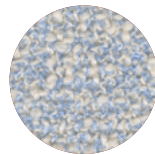

Zucchero

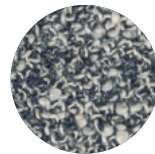

Petrolio

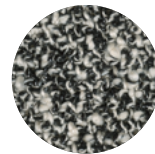

Sale e pepe

TESSUTI | FABRICS

C

DEDAR TIGER BEAT

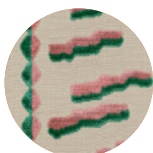

Fragola menta



Papaya



Fauve



Tabacco

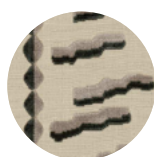

Fumo

DEDAR AMULETO



Corallo



Rubino

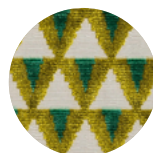

Smeraldo



Alabastro



Occhio di tigre